



Linkam Scientific Instruments

CSS450
Optical Rheology System

USER GUIDE

Contents

Safety Information	4
Important Notice	4
Requirements for Safe Use.....	4
Caution Labels and Indicators	4
Handling Liquid Nitrogen	4
Filling the Dewar.....	5
Equipment Maintenance	5
Informations de sécurité	5
Note importante	5
Exigences en matière de sécurité d'utilisation.....	5
Étiquettes d'avertissement et indicateurs.....	6
Manipulation de l'azote liquide	6
Remplissage du vase Dewar.....	6
Entretien de l'appareil	6
Introduction	7
Before using your equipment	7
Warranty.....	7
Technical support	7
Feedback	7
Equipment Operation	7
Introduction to CSS450 stage	8
Anatomy of a CSS450	9
Accessories	10
Getting Started	11
Installing Linksys32 on a PC	11
Stand Assembly.....	11
Assembling the Lid and Base.....	12
Connecting the Lemo cable	12
Mounting on to a Microscope	13
Mounting on to a Dovetail.....	13
Set up Kohler Illumination	13
Introduction to CSS450 System Controller	14
Back Panel Cable Connections	14
Stage Connector.....	14
Instrument Bus	14
Expansion Boards	14
External Input and Output Sockets	14
USB Connector.....	14
RS232 Connector.....	14
LinkPad Connector	14
LNP95 Liquid Nitrogen Pump.....	15
Introduction.....	15
Remove Transit Screws	15
Connecting the Stage to the Controller.....	16
Mains Connection.....	16
Connecting the Water Cooling Supply / Circulator.....	17
Connecting the Liquid Nitrogen Pump for Cryo-CSS450 System	18
Connecting the LNP95	18
Setting up the Linksys32 Software	20
Changing the Comm Port Number.....	21

Using Linksys32 Software	21
Linksys32 Tool Bar	22
CSS450 Tool Bar	22
CSS Status Window	22
Sensor Indicators	22
Jog Controls (Manual Mode)	22
Loading the Sample	23
Start the Shearing Experiment	24
Using the Shear Motor Profile	24
Start the Profile	26
Adjusting The Shear Parameters	26
General Setup	26
Velocities	26
Finish a Shearing Experiment	27
Maintenance Procedures	28
Changing the Windows	28
External Window Replacement	28
Base Window Replacement	28
Lid Window Replacement	29
Setting the Sensors - Zero, Lid and Reference	30
Manually Setting the Windows to Zero Point	30
Using the CSS-450 Gas Purge and Vertical Seal stage	35
Using the Purge ports	35
Base Window Replacement	35
Troubleshooting	36
Unable to set a gap, Lid seems stuck	36
Comm port message	36
Motor doesn't start	36
Lid can rock slightly when the lid nuts are off	37
Temperature appears to be several degrees below the displayed temperature	37
Cooling Fault Diagnosis	37
The cooling rate is less than Specified	37
Appendix 1 : Shear and Strain Explanation	38
Shear Control	38
Shear Rate	38
Strain (Shear) value	38
Observation Radius	38
Appendix 2 : Spare Parts List	39
Appendix 3 : Declaration of Conformity	40
Appendix 4 : Technical Specification	41
CSS450 Stage Technical Specification	41
CSS450 Controller Technical Specification	41
CSS450 Controller Equipment Ratings	41
RS232 Computer Interface	41
USB Interface	41
External input and output sockets	41
CSS450 Motor Board	42
Optional LinkPad	42
LinkPad Equipment Ratings	42
LNP95 Liquid Nitrogen Pump	42
LNP95 Equipment Ratings	42
Contact Information	44

Safety Information

Important Notice

Please check that your Linkam equipment has not been damaged during transport.

If there is any evidence of external damage to the electrical items:-

do not connect the power cord or switch the unit on.

Contact Linkam Scientific Instruments Ltd or their appointed distributor immediately. Your warranty may be impaired if Linkam is not informed of any transport damage within 7 working days of delivery.

Requirements for Safe Use

1. Read all of this guide before using the equipment. Save these instructions for later use.
2. Follow all warnings and instructions marked on any of your Linkam equipment, or contained within the manuals.
3. If for any reason the mains fuse needs to be replaced then it must be replaced by one of the same type and rating as shown in the equipment ratings.
4. To prevent electric shock, do not remove the cover of the equipment.
5. Never use the equipment if the power cord has been damaged. Do not allow any heavy objects to rest on the power cord. Never lay the power cord on the floor.
6. The mains cord set is the overall disconnect and must remain accessible.
7. If the equipment is used in a manner not specified by the manufacturer, the protection provided by the equipment may be impaired.
8. Do not obstruct any ventilation holes. Do not attempt to insert anything into these openings. Provide adequate ventilation of at least 75mm all around the equipment.
9. Do not expose the equipment to water. If for any reason it gets wet, then remove the power cord from the mains outlet and contact Linkam Scientific Technical Support.
10. The equipment is not intended to be used outdoors.
11. Each product is equipped with a 3-wire grounded (earth) power plug or a free-end 3 wire power cord. The plug only fits into a grounded-type outlet. The free-end power cord should be connected to a correctly grounded 3-wire power outlet. Do not defeat the purpose of the grounded (earth) type plug. Free - end power cords are colour coded as follows:-

Colour	Function
Brown	Live
Blue	Neutral
Green/Yellow	Earth (Ground)

12. The power cord must be an appropriately rated and approved cord-set for the country it is being used in.
13. If any problems occur then remove the power cord from the mains outlet and contact Linkam Scientific Technical Support.
14. NO attempt should be made to repair or modify the equipment in any way, as there are no user replaceable parts. Any servicing should be carried out by qualified service personnel. Do not remove the cover from the equipment unless the power cord has been removed from the mains outlet.
15. After servicing the safe state of the equipment must be checked.

Caution Labels and Indicators

This safety symbol on the back panel warns the user :

Do not to make or remove any connections while the unit is powered on.

Do not to remove the cover.

Servicing should only be done by qualified service personnel.



This safety symbol is seen on the back panel of the equipment and warns the user:

To avoid electric shock the power cord protective grounding conductor must be connected to earth or ground.

Handling Liquid Nitrogen

To cool samples below room temperature a CSS-LNP95 liquid nitrogen pump system is required. Always use liquid nitrogen in a well ventilated room as there is a danger of asphyxiation.

Refer to your health and safety officer regarding instructions on how to handle liquid nitrogen safely and ensure that you have the correct safety equipment including gloves and safety goggles.

Filling the Dewar

Fill the Dewar approximately 2/3 full and replace the lid with the siphon attached, but *do not fasten the catches*. Wait for the liquid nitrogen to stop bubbling before fastening.

When the lid is removed always ensure you place it with the black capillary tube pointing upwards. It is easily damaged or creased which will impair N₂ flow and the performance of the system.

Equipment Maintenance

The equipment does not require any regular maintenance. Contact Linkam should you require any maintenance. Before cleaning the case or front panel of the equipment, remove the mains cord from the mains outlet. Use a small quantity of isopropyl alcohol (IPA) on a soft cloth and gently wipe the surface.

Informations de sécurité

Note importante

Veillez vérifier que votre appareil Linkam n'a pas été endommagé pendant le transport. S'il présente une trace quelconque d'endommagement aux éléments électriques :

ne raccordez pas le cordon d'alimentation et n'allumez pas l'appareil.

Contactez Linkam Scientific Instruments Ltd ou son distributeur désigné immédiatement. Votre garantie pourrait être réduite si Linkam n'est pas informée de tout dommage causé par le transport dans les 7 jours ouvrables suivant la livraison.

Exigences en matière de sécurité d'utilisation

1. Lisez ce guide intégralement avant d'utiliser l'appareil. Conservez ces instructions pour un usage ultérieur.
2. Suivez toutes les mises en garde et instructions marquées sur toute pièce de votre appareil, ou figurant dans les manuels.
3. Si pour une quelconque raison le fusible secteur doit être remplacé, il faut le remplacer par un fusible du même type et avec les mêmes caractéristiques nominales que celles indiquées dans les caractéristiques nominales de l'appareil.
4. Pour prévenir l'électrocution, n'enlevez pas le couvercle de l'appareil.
5. N'utilisez jamais l'appareil si le cordon d'alimentation a été endommagé. Ne laissez pas d'objets lourds appuyés sur le cordon d'alimentation. Ne posez jamais le cordon d'alimentation sur le sol.
6. Le secteur cordon est la déconnexion globale et doit rester accessible.
7. Si l'équipement est utilisé d'une manière non spécifiée par le fabricant, la protection fournie par l'équipement peut être altérée.
8. N'obstruez aucun des orifices de ventilation. N'essayez pas d'insérer quoi que ce soit dans ces ouvertures. Prévoyez un espace de ventilation adéquat d'au moins 75 mm autour de l'appareil.
9. N'exposez pas l'appareil à l'eau. Si pour une quelconque raison l'appareil est mouillé, retirez le cordon d'alimentation de la prise de courant et contactez le support technique de Linkam.
10. L'appareil n'est pas destiné à un usage à l'extérieur.
11. Chaque produit est équipé d'une fiche d'alimentation mise à la terre ou d'un cordon d'alimentation avec 3 fils à extrémité libre. La fiche ne s'insère que dans une prise de courant mise à la terre. Le cordon d'alimentation à extrémités libres doit être raccordé à une prise de courant à 3 fils correctement mise à la terre. N'empêchez pas le fonctionnement de la fiche mise à la terre.

Les cordons d'alimentation à extrémité libre suivent les codes couleur suivants :

Couleur	Fonction
Marron	conducteur de phase
Bleu	conducteur neutre
Vert/jaune	mise à la terre

12. Le cordon d'alimentation doit être constitué d'un ensemble de câbles répondant aux caractéristiques nominales et approuvé dans le pays d'utilisation.
13. Si un problème survient, débranchez le cordon d'alimentation de la prise de courant et contactez le support technique de Linkam.
14. Il convient de NE PAS tenter quoi que ce soit pour réparer ou modifier l'appareil en aucune façon, dans la mesure où il n'y a aucune pièce remplaçable par l'utilisateur. Tout entretien doit être effectué par du personnel qualifié. N'enlevez le couvercle de l'appareil que si le cordon d'alimentation a été débranché de la prise de courant.
15. Après l'entretien de l'état de sécurité de l'équipement doit être vérifiée.

Étiquettes d'avertissement et indicateurs

Ce symbole de sécurité sur le panneau arrière avertit l'utilisateur :

N'effectuez ou n'enlevez aucun raccordement quand l'appareil est sous tension.

N'enlevez pas le couvercle.

L'entretien doit être effectué exclusivement par du personnel qualifié.



Ce symbole de sécurité est visible sur le panneau arrière de l'appareil et avertit l'utilisateur :

Pour éviter l'électrocution, le conducteur de protection du cordon d'alimentation doit être raccordé à la terre.



Manipulation de l'azote liquide

Pour refroidir les échantillons en dessous de la température ambiante, un système de pompe à azote liquide LNP95 est requis. Manipulez toujours l'azote liquide dans un local bien ventilé, car il présente des risques d'asphyxie.

Référez-vous à votre agent de santé et sécurité en ce qui concerne les instructions sur la manière de manipuler l'azote liquide de façon sûre et assurez-vous de porter l'équipement de sécurité adapté incluant des gants et des lunettes de protection.

Remplissage du vase Dewar

Remplissez le Dewar jusqu'à environ 2/3 et remplacez le couvercle par le siphon attaché, mais **ne scellez pas les fixations**. Attendez la fin du bouillonnement de l'azote liquide avant de sceller le Dewar.

Lorsque le couvercle est enlevé, assurez-vous de la déposer avec le tube capillaire noir pointant vers le haut. Il peut être facilement endommagé ou plié, ce qui affecterait le flux de N₂ et la performance du système.

Entretien de l'appareil

L'appareil ne nécessite pas d'entretien régulier. Contactez Linkam si vous souhaitez procéder à un entretien.

Avant de nettoyer le boîtier ou le panneau avant de l'appareil, débranchez le cordon secteur de la prise de courant. Utilisez une petite quantité d'alcool isopropylique (IPA) sur un chiffon doux et frottez délicatement la surface.

Introduction

Thank you for purchasing a Linkam system. Please take the time to read through all the manuals, as it will help you to fully understand the equipment.

Please check you have received the following items:-

- 1: CSS450 System Controller
- 2: Power cord
- 3: RS232 cable for PC connection
- 4: USB Type A to B cable
- 5: Manual
- 6&7: Optional LinkPad and Stylus

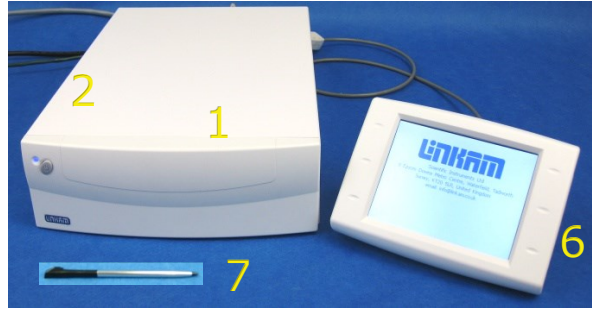

Before using your Equipment

Please register your products by going to www.linkam.co.uk and clicking on the product/software registration button. You will need to register your equipment with us to:

Activate your warranty and technical support.

Access the online setup videos.

Permanently unlock the Linksys32 software by use of a product key (if purchased).

To unlock the Linksys32 software a product key must be requested which is supplied by Linkam from a customers product registration number. This is generated after installing the Linksys32 software by running the register program from Start-Programs-Linkam-Register. See the Linksys32 manual for further installation instructions.

Warranty

This equipment has a warranty against defects in material and workmanship for a period of 12 months. Linkam will either repair or replace products that prove to be defective. For warranty service or repair, this product must be returned to Linkam or a designated service facility.

The warranty shall not apply to defects resulting from interfacing, unauthorized modification or misuse, operation outside of the environmental specifications for the product, or improper site preparation or maintenance.

Technical Support

Any technical questions or queries should be emailed to the Technical Support Department at support@linkam.co.uk

Feedback

Your feedback will be greatly appreciated, please go to www.linkam.co.uk to fill in the feedback form.

Equipment Operation

Warning:

Do not connect or remove any leads to the CSS450 Controller while the unit is switched on at the mains supply. All connections must be in place before the CSS450 Shear Controller is switched on.

If an LNP95 unit is being used it is important that it is switched on before the CSS450 unit, otherwise the equipment will not function correctly.

Introduction to CSS450 Shear Stage

Thank you for purchasing the CSS450 system. The Cambridge Shearing System (CSS450) has been developed in collaboration with the Department of Chemical Engineering at Cambridge University.

The stage and its accessories are packed in the protective hard plastic case. It's recommended that you use this case to store the stage, when it is not in use for a long period of time.

The CSS450 Shear Stage is made up from two parts, the Lid and Base (see pictures). The stage is designed to fit on most standard upright microscopes and has a temperature range from ambient (-50°C for Cryo-CSS450) to 450°C.

Please take the time to read through this manual carefully, it will help you to get the most out of the system.



CSS450 System



Lid

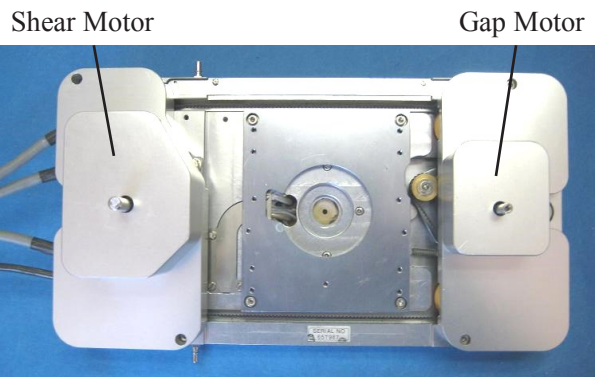

Base

Anatomy of a CSS450

When in use, the sample is placed between two highly polished quartz windows that are parallel to within 2mm and each window is in close thermal contact with a silver heater. The Base window, located within the lower section of the shearing stage, is attached to a metal carrier that can rotate under the control of the Shear Motor. This motor is micro-stepped and has a specification of 51200 steps per revolution.

The Shear Motor can drive the system in three ways; steady velocity, step movement at constant velocity and an oscillatory motion with constant frequency and amplitude.

When in use, the Lid is fixed on top of the Base. The gap between the windows can be set from 5 to 2500 μm and this is controlled by a stepping Gap Motor and micrometer built inside the body of stage. The speed at which the Lid moves up and down may also be set. Sensors in the body of the stage and Lid will determine the upper and lower limits.

1. Water cooling connectors
2. Window clamping ring
3. 32mm tapered quartz Lid window (W32TQ)
4. 55mm quartz Base window (W55Q)
5. Window carrier

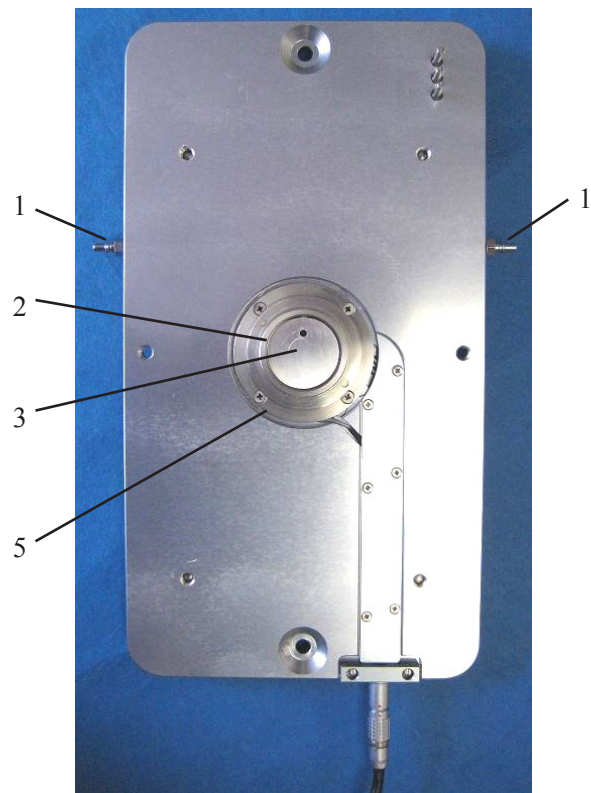

Lid

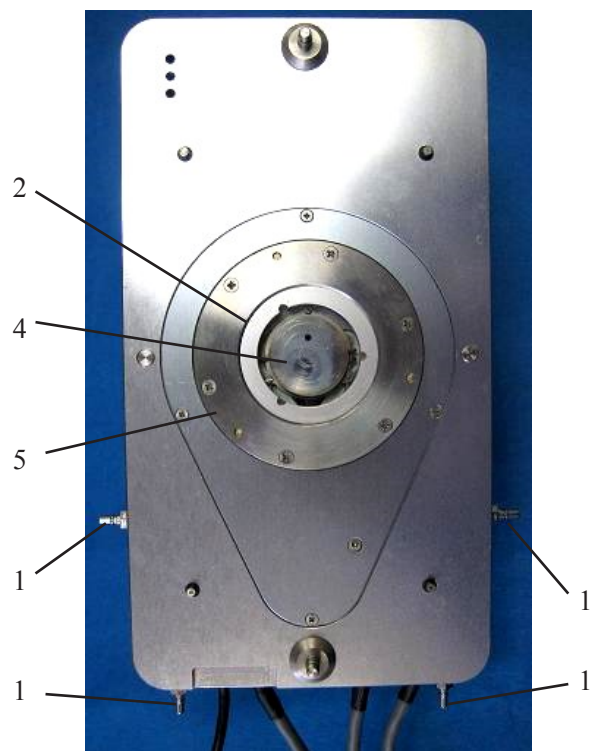

Base

Accessories

The accessories for the stage are supplied in an accessories kit (part no: 2053), containing the items in the picture below.

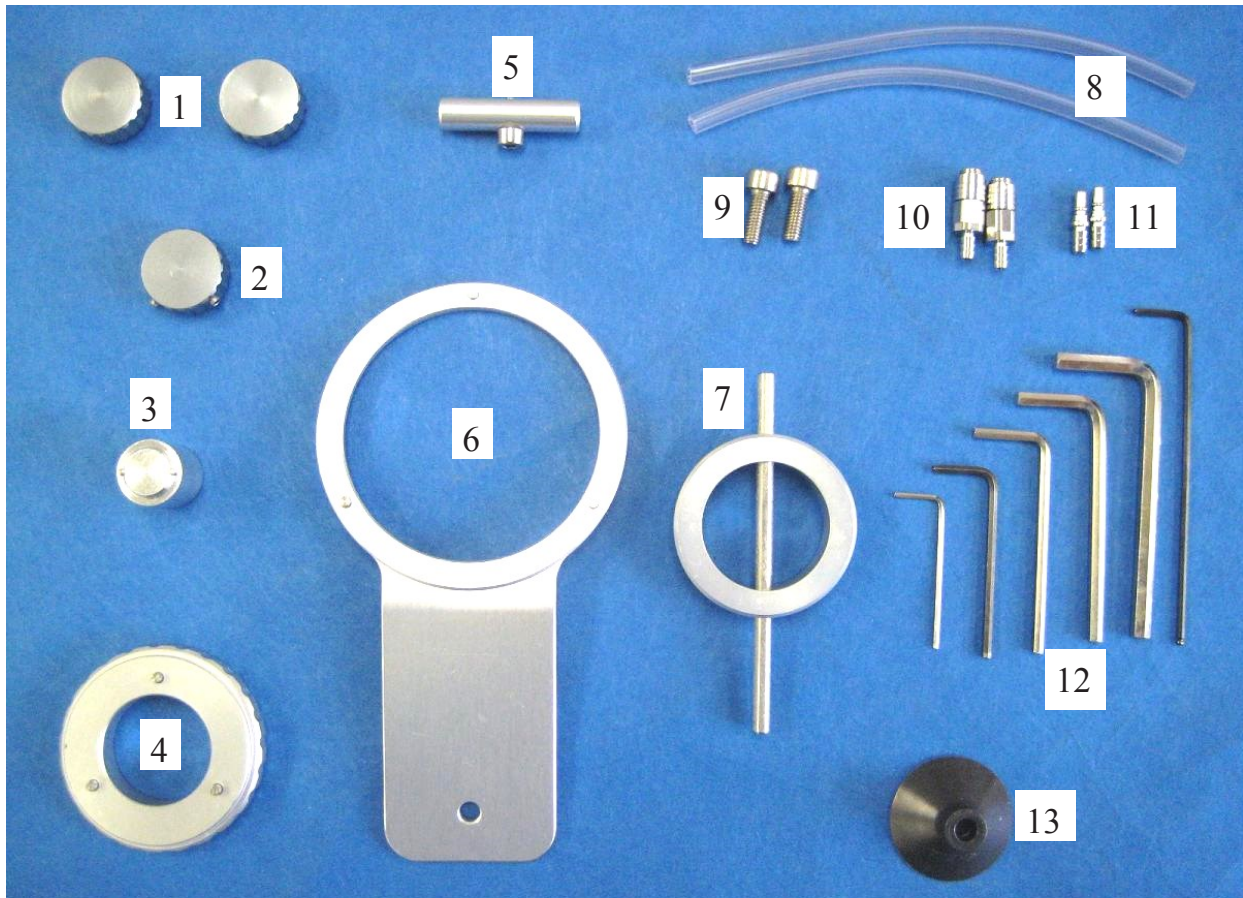

Number	Part number	Part description
1	3016	Lid Nut (CSS-LN)
2	3033	Motor Nut
3	3011	18mm External Window Locking Tool
4	2912	55mm Window Clamp Tool
5	3003	Sensor Adjustment Tool
6	2047	Base Window Carrier Tool
7	3076+2911	Lid Window Clamping Tool and Tommy Bar
8	2055	Clear PVC Water Cooling Tube
9	2473	Lid Jacking Screw, M6x16mm
10	2202	Water Valve Connectors (WVC)
11	2200	Water/Gas Insert (WGI)
12	N/A	Set of Allen (hex) keys, 1.5, 2.0, 2.5 (ball point), 3.0, 4.0, 5.0mm,
13	3078	55mm Window Sucker Tool

Getting Started

When fully unpacked, check for the following items; CSS450 'Controller', a mains power lead, RS232 lead and a CD with Linksys32 software.

In a separate dedicated plastic case there will be a complete CSS450 Shearing 'Stage' consisting of the Lid, the Base, a flat packed Stand and an accessories kit.

Installing Linksys32 on a PC

Before getting started with the stage, it is advisable to load the Linksys32 software onto the PC (see Linksys32 Manual) and register the software with Linkam.

Note: The CSS450 Controller requires a PC equipped with a Comm port (RS232 connection), for the Controller to link with the PC. If the PC does not have a Comm port, consult your IT department to install a Comm port PCI card or a USB-to-Comm port adaptor.

Stand Assembly

Assemble the Stand as shown in the pictures, using the supplied 4.0mm hex key.

The Stand is useful for holding the Lid while a sample is loaded or when the windows are cleaned.

It can also be used to rest the complete shearing stage on when testing or when it is not in use on the microscope.



CSS450 System

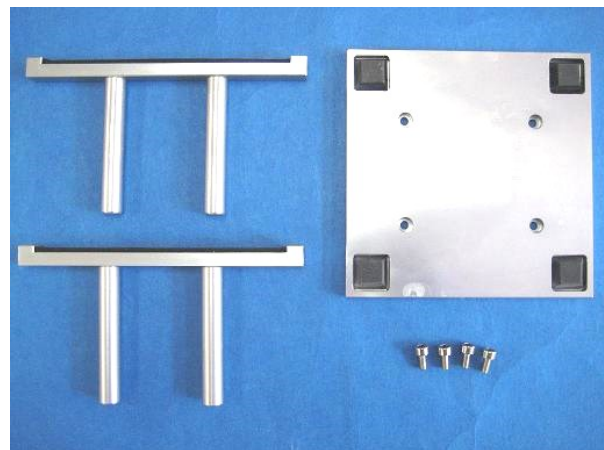

Assembling the Lid and Base

1. Place the Base on the Stand.
2. Place the Lid on top of the Base. Make sure the three holes at the top right hand side corner of the Base are aligned and matched with the three sensor pins on the Lid (1).
3. Use the two Lid Nuts supplied and screw them into place, hand tight only. The user might need to use a finger to push and lift upward the protruding shaft, which is located directly underneath each thread to give more threads for the Lid Nut to screw on to.

The Lid can be removed by doing the reverse of the above procedure. If the Lid Nut turns but does not unscrew, the Lid Nut may have been screwed on too tightly. Press one finger and hold the protruding shaft underneath the stage to stop it turning.

Note: Protective Caps

There are four of these fitted over the alignment screws located in the lid. **THESE SHOULD NOT** be removed under any normal circumstances. They are aligned at the factory and any attempt to change these in any way will invalidate the warranty.

Connecting the Lemo Cable

There are four leads connected into the Base. Connect the shortest cable which has a Lemo plug connected to it, into the Lemo socket in the Lid. Line up the red dot on the plug with the red dot on the socket.

This lead will provide the heating power and connect the temperature sensor to the Lid.

When removing the Lid. The Lemo cable can remain connected to the Lid if required, but use the Stand to rest the Lid on.

Note: to disconnect the Lemo, e.g. to make cleaning the stage easier., hold the socket firmly and gently pull the plug away from the Lid.

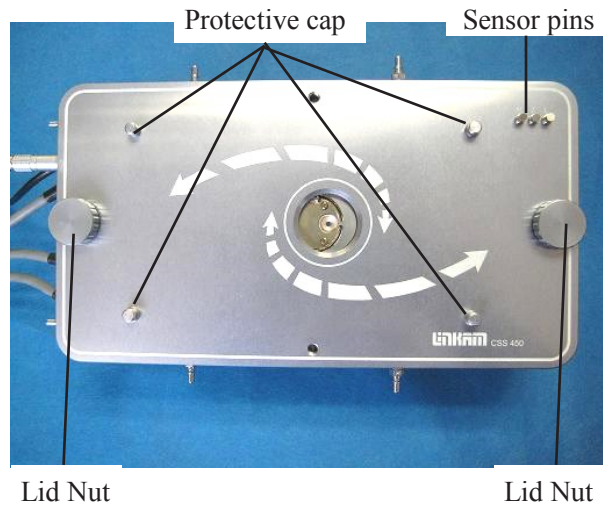
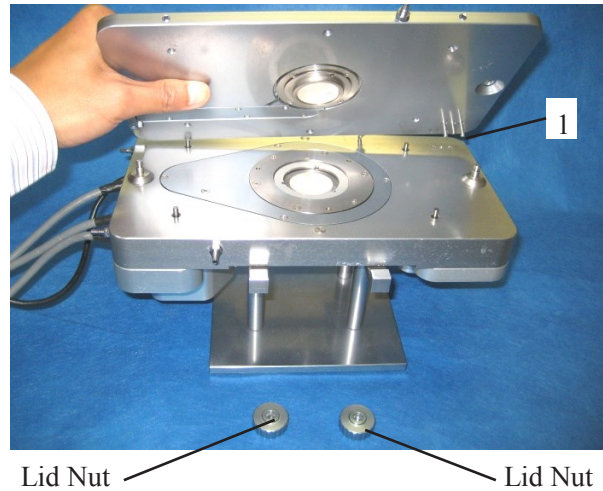

Mounting on to a Microscope

The microscope make and model was specified at the time of order, and the clamping set or adaptor plate are supplied specific to that set up.

Note: The CSS450 stage requires the objective lenses to have a minimum working distance of 7.4mm.

Mounting on to a Dovetail

The following description for mounting the stage on the Linkam Imaging Station can also be applied to microscopes which have similar circular dovetail substage assemblies.

Attach the Curved Clamps (part no. 9548) to the Microscope Fixing Plate (1), using the supplied hex screws (2.5mm) and to the outer most holes of the Microscope Fixing Plate.

The two curved clamps are used to fix the CSS450 to the microscope. To do this; adjust the two positioning screws (2) and thumb screw (3) so that they are showing about 5mm of thread on the inside edge of the Curved Clamps. This will roughly position the stage in the centre of the dovetail.

Place the Base onto the dovetail and using a 5x or 10X objective lens, focus on the aperture of the heating block. Using a hex screw driver to adjust the two positioning hex screws (2), so that the aperture is in the centre field of view of the optical light path. Then use the thumb screw (3) to lock the stage in place.

Set up Kohler Illumination

Kohler illumination is a technique that provides optimum resolution and contrast in a light microscope by aligning and focussing the transmitted illumination and critically setting the apertures of the microscope to best match the objective lens Numerical Aperture.

To use Kohler illumination with the CSS450, a condenser lens with a minimum working distance of 15mm is needed. Contact Linkam for further information about condenser extension lenses.

For information about setting up Kohler Illumination and how to set up your microscope. See the extremely informative 'microscopy Primer' on the Molecular Expressions website.

<http://micro.magnet.fsu.edu/primer/index.html>

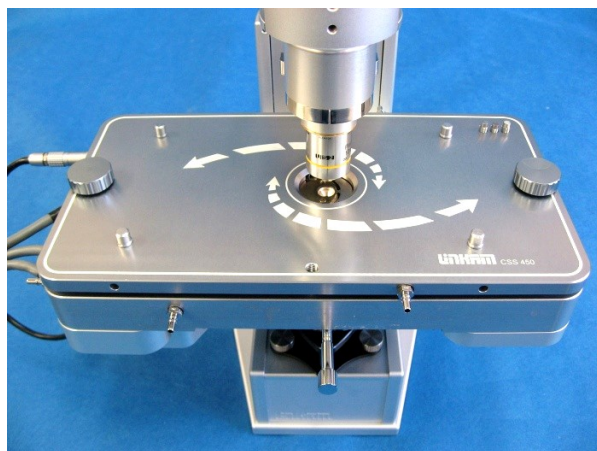
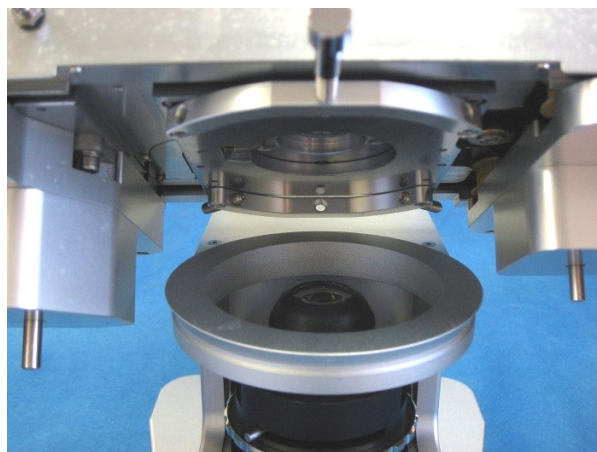
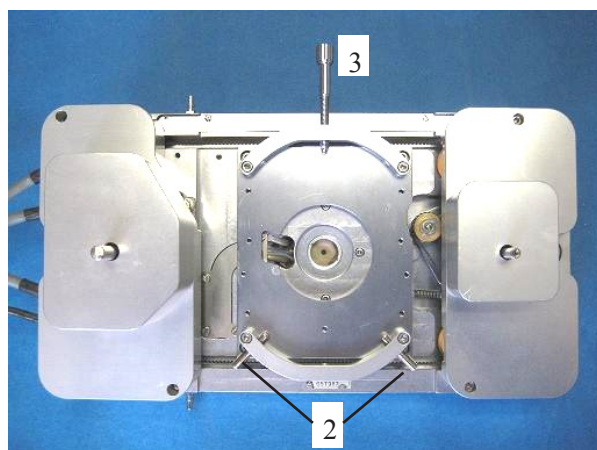
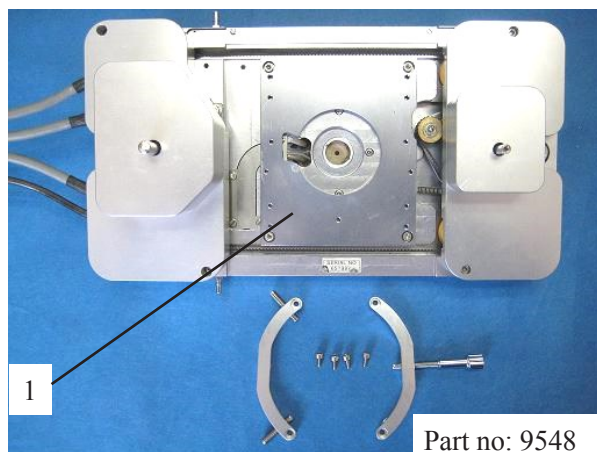

Introduction to CSS450 System Controller

Back Panel Cable Connections

Warning: To avoid any damage to the CSS450, switch the unit off before connecting or removing any connections.

- 1: Power socket
- 2: Fuse holder
- 3: Instrument Bus connector, for LNP95 Liquid Nitrogen pump System.
- 4: RS232 connector for PC Comm port connection.
- 5: USB connector (used for firmware upgrade only).
- 6: External input and output sockets.
- 7: Stage connector.



Stage Connector

This supplies power to the stage and measures the temperature using platinum resistor sensors.

Instrument Bus

This connection is only used for the LNP95 Liquid Nitrogen Pump. If your stage has been supplied with an LNP95 then a cable will have been provided which is used to connect the CSS450 to the LNP95.

It may be necessary to pull back the sprung mounted violet moulding towards the cable before inserting the connector.



Expansion Boards

The CSS450 requires a motor expansion board, which requires the 'motor' and 'sensor' leads to be connected correctly.

Any of the stages which use an expansion board will be marked with the same label as the CSS450 expansion board.

External Input and Output Sockets

There are three 2.5mm jack sockets (6) on the rear of the CSS450 for synchronising or controlling external equipment, see page 39 for the electrical specifications.

USB Connector

At present this is only used for updating the firmware in the CSS450 .

RS232 Connector

For a PC connection use the supplied RS232 **crossover** cable.

LinkPad Connector

If you have purchased a LinkPad then plug it into the LinkPad connector (3).

LNP95 Liquid Nitrogen Pump

Only read the following if the LNP95 Liquid Nitrogen Cooling Pump System is supplied with your system. The LNP95 System uses liquid nitrogen to cool the stage from ambient to -196°C . The speed of the LNP95 is automatically controlled from 1 to 100 by the CSS450. **Note:** refer to the LNP95 manual for more information

Introduction

Please check that all of the following parts have been supplied with the LNP95 System.

1. LNP95 Liquid Nitrogen Pump
2. 2L Dewar (7L or 25L Dewar is available)
3. Power cord
4. Instrument Bus Cable for connection to the CSS450



Remove Transit Screws

Before using the LNP95 Liquid Nitrogen Pump System, remove the 4 transit screws marked by small yellow labels (5), from the base of the LNP95. These screws hold the pumps in place to avoid any damage in transit.

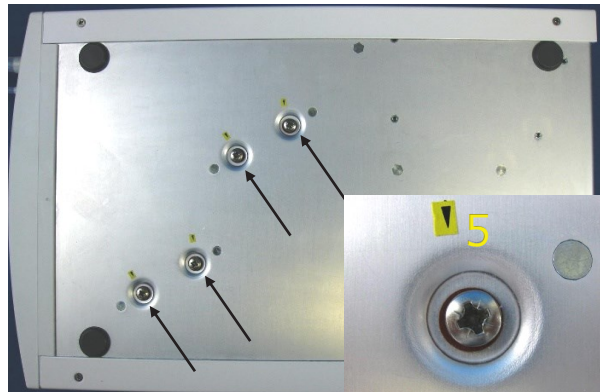

Keep the screws safe by storing them in the holes (6) on the back panel as shown by the arrows.

Should the LNP95 be returned for service or repair, the screws must be removed from the storage holes and used to secure the pumps for transit (5).



Connect the Stage to the Controller

The CSS450 Controller controls the temperature and the Shear and Gap motors of the stage.

Refer to the back of the controller. Connect the supplied RS232 lead from the RS232 socket on the back of the controller to the PC's serial/Comm port. All the long leads from the Base should be connected to the back panel of the controller. Each connector is unique and cannot be inserted into the incorrect socket.

Make sure that the two screws on "D" type connectors are tightened.

Mains Connection

Once the RS232 lead between the computer and the controller is in place, it does not matter which one is powered on first. Plug the mains connector into the back of the controller and then into the mains outlet. Use the On/Off switch to turn the power on or off.

Note: do not remove any of these connections while the controller is powered on as this could damage the equipment.

No attempt should be made to modify any of the connections to the CSS450 Controller. Warranty will be void.

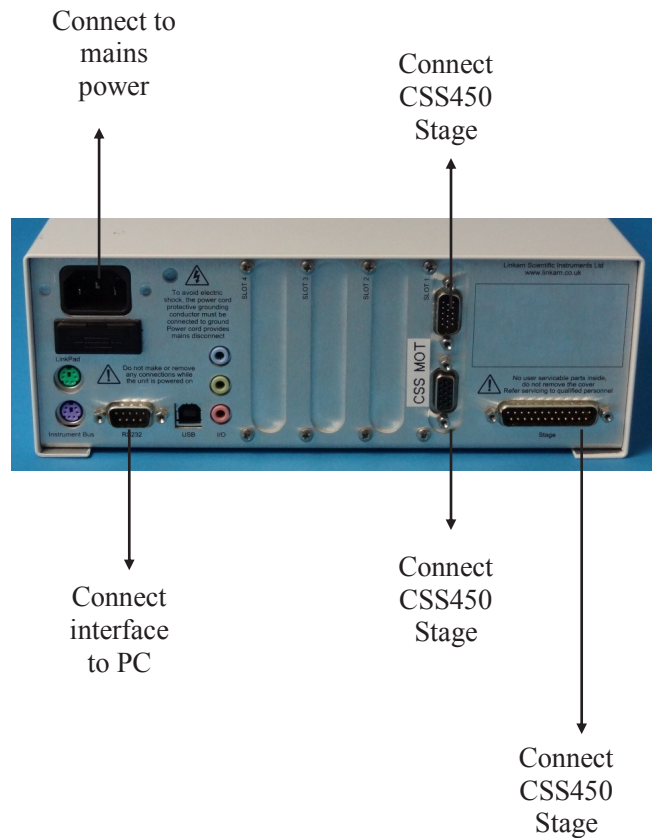

Connecting the Water Cooling Supply/Circulator

When the CSS450 is used at temperatures exceeding 200°C for a prolonged period of time it will become warm/hot to the touch. To ensure that the stage is always safe to handle, a system of water-cooling is recommended.

Either a low-pressure water supply (mains) or a water pump may be used with a flow rate of approximately 0.3l/m.

Linkam can supply a portable water circulator pump system (ECP) for this application.

Some connectors and tubing are supplied with the stage. (Water connections at sides of stage need to be fitted using a 7mm spanner). The tube has an inner diameter (I.D) of 3.0mm and an outside diameter (O.D) of 6.0mm. To ensure even cooling of the complete stage, connect the tubes to the stage as shown.

Note: cut the tubing to a manageable length. i.e. not too long as it might tangle up and not too short, so that when Lid is taken off the Base, it can be placed on the Stand



Water inlet
(Base)

Water outlet
(Lid)



Bypass loop
(Base connection)

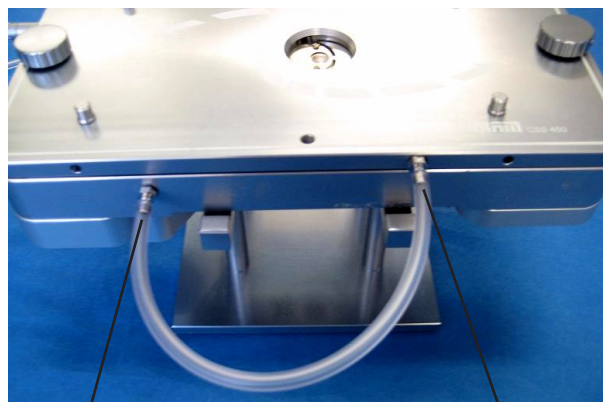

Base
connection

Lid
connection

Connecting the Liquid Nitrogen Pump for Cryo-CSS450 System

Note: this is only appropriate if you have purchased the Cryo-CSS450 system. If not then go to the section, “Setting up the Linksys32 Software”, page 18.

A Cryo-CSS450 system adds liquid nitrogen cooling functionality to the CSS450 stage. A dual output LNP95 Liquid Nitrogen Cooling Pump, 2L Dewar, power cable and I2C cable will be included as additional parts.



Cryo-CSS450 System

Connecting the LNP95

Connect the CSS450 Controller as described on page 14 of this manual and connect the Instrument Bus cable from the CSS450 controller to either one of the two Instrument Bus sockets on the LNP95.

Fill the 2L Dewar with liquid nitrogen to approximately 2/3 thirds full and replace the lid. **DO NOT FASTEN** the clips on straight away (read Safety Precaution; Handling Liquid Nitrogen, page 4 for more information). Wait until the nitrogen has stopped boiling before fastening the catches. Excess pressure can escape through the Teflon cap on the lid.

There is a white plastic block on the base and on the top of the lid. These blocks have two connectors extending from them. One is for the cooling pump (labelled LNP) and the other is for the Dewar siphon (labelled DF2).

The CSS-LNP95 cooling pump has two silicon tubes extending from the front panel. These tubes end in plastic white connectors with a 3mm outer diameter (O.D.) stainless steel side exhaust tube. Twist and gently push these white connectors onto the thin steel connectors on the Lid and base, labelled ‘LNP’. The bottom LNP siphon should connect to the base heater, and the top LNP siphon to the lid heater.

The Dewar siphons assembly protrude from a large Teflon cap on the top lid of the Dewar. The siphons are labelled ‘Lid’ and ‘Base’. A thin black capillary tube extends from the end of each siphon, these tubes must be carefully inserted into the small steel connector protruding from the white blocks and labelled DF2.

Main cable power socket

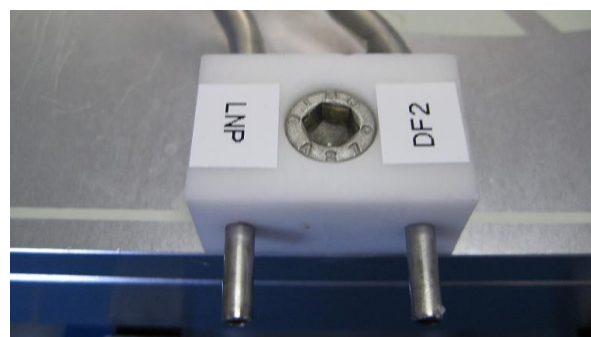
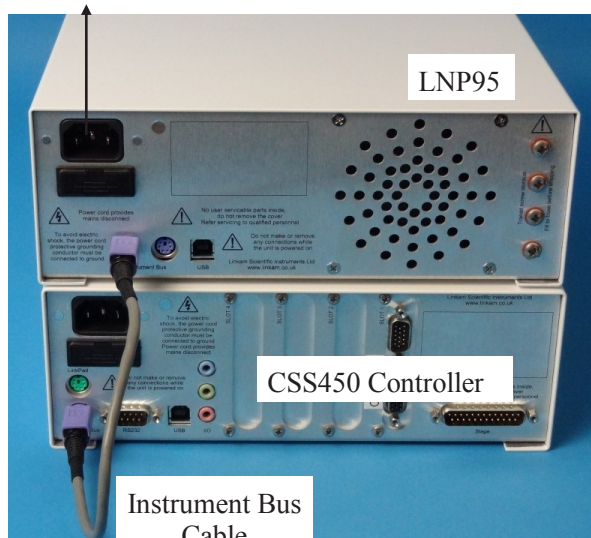

The small side exhaust tubes (1) protruding from the white connectors at the end of the LNP tubes vent the recycled nitrogen into the atmosphere.

Silicon tubes (2) can be attached to these exhausts to utilise the recycled nitrogen that vent to the atmosphere to prevent condensation at the Lid or Base, or to simply flow nitrogen into the gap between the Lid and Base. These tubes can be fixed into place using adhesive tape (3). Variable lengths of silicon tube (O.D. 4mm, I.D. 2mm) can be sourced locally or directly from Linkam.

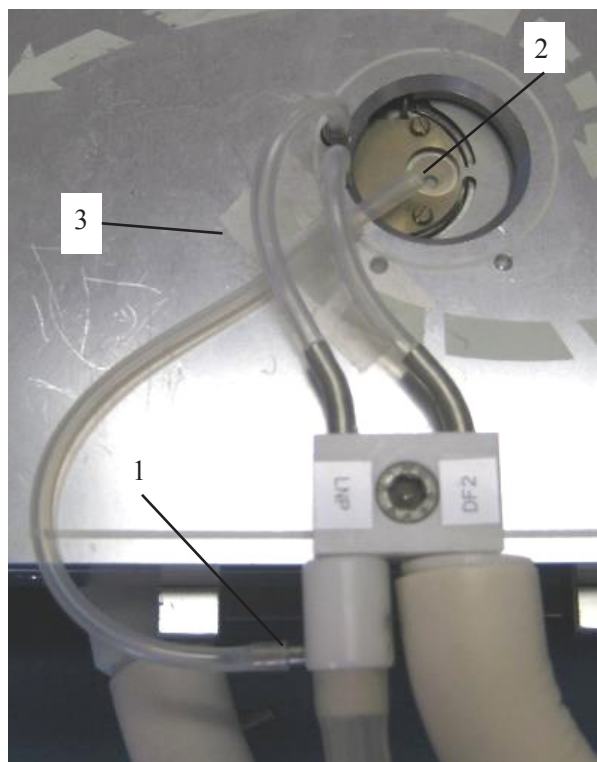

When all the connections have been made, the CSS450 is ready to be used to cool the sample below room temperature to -50°C .

The CSS450 Controller will communicate with the Liquid Nitrogen Pump (LNP95) and select the correct pumping speed automatically to follow the programmed temperature profile.

Refer to Linksys32 Manual for information on how to program the temperature.

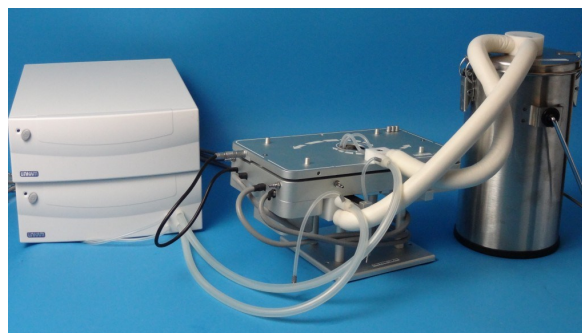

Setting up the Linksys32 Software

Ensure that the RS232 cable is connected between the PC serial RS232 port (Comm port) and the CSS450 controller. Start the Linksys32 software by double clicking on the 'Linksys32 - Shortcut' icon on the PC. The temperature Control Status Display will show the message:

'**No Comm** Programmer not connected'.

This means that the software does not yet recognise the Controller connected to the RS232 Comm port.

Got to: **File > Connect**

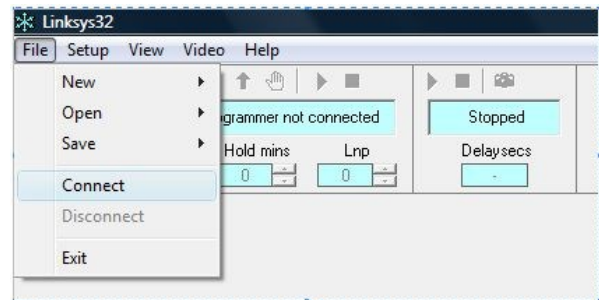
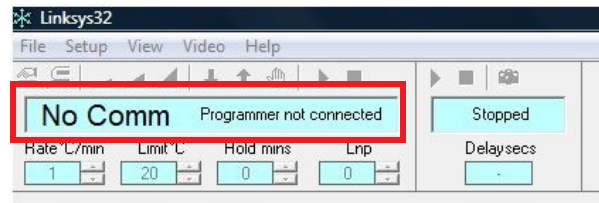

The software will now ask to 'Power on your Linkam equipment connected to comm port1' (or whichever Comm port has been selected in the Linksys32 Setup window).

Click: **OK** button.

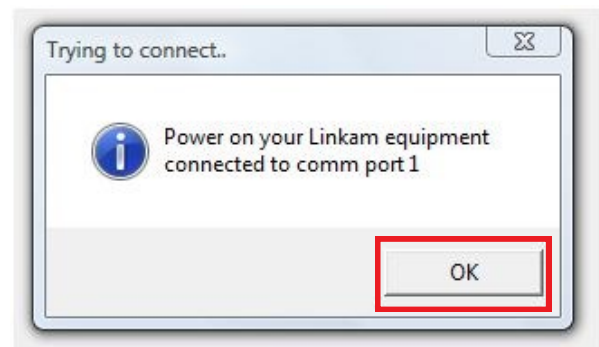

If the following message appears:

'**No Comm** Cannot open the comm port'

The RS232 cable may have been connected to a different Comm port number other than the one selected in the Temperature Programmer Setup menu.

Check the back of the PC to see which Comm port the RS232 cable is connected to.

Note: if the Comm port is from a PCI card or USB-to-Comm port adaptor, it will not be a Comm port1 setting.

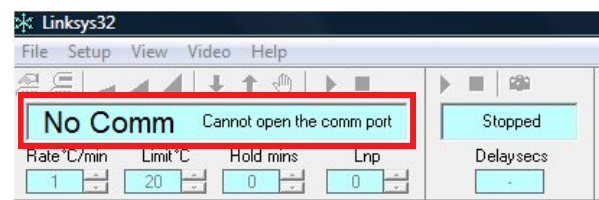

Changing Comm Port Number

Go to: **Setup > Temperature Controller**

In the popup window 'Linksys32 Setup' make sure 'TempControl' is selected. Use PC mouse to select the Comm port (2 to 6) the RS232 cable is connected to, then click the 'X' button in the top right hand corner to close the window.

Check the controller is on.

Now connect as before: **File > Connect**

The software will again ask for 'Power on your Linkam equipment connected to comm port1' or whichever Comm port has been selected in the Linksys32 Setup window.

Click: **OK**

When a successful connection has been made, the software will show 'Linksys32 : Connected to > CSS 450' in the title bar and show the live temperature in the display.

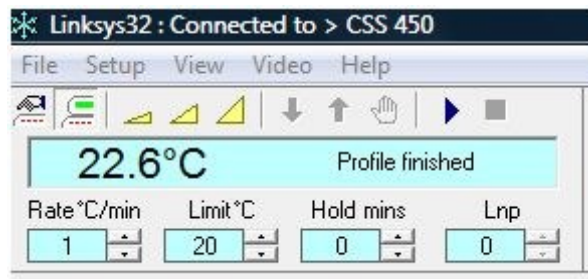
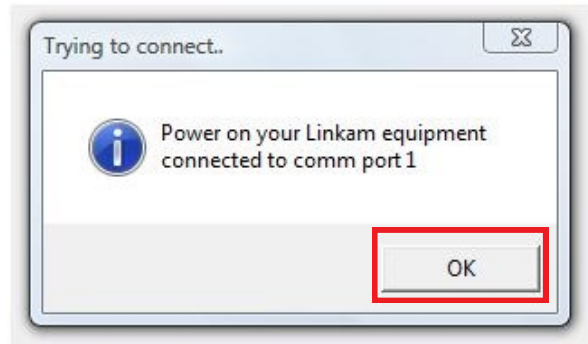
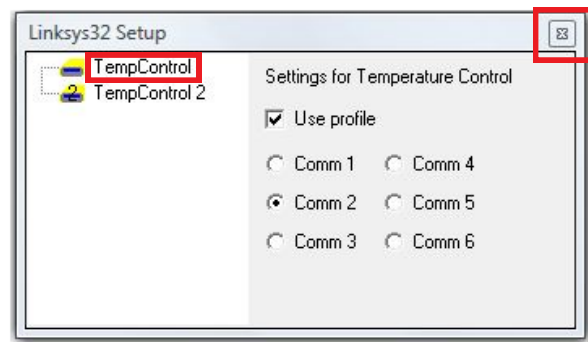

Using Linksys32 Software

Linksys32 Tool Bar

If the system has connected to the PC successfully, the Tool Bar control panel will appear as shown. This tool bar has three sections. Refer to Linksys32 Manual for the operation of the Temperature and Video Capture Tool Bar.



Linksys32:
Tool Bar

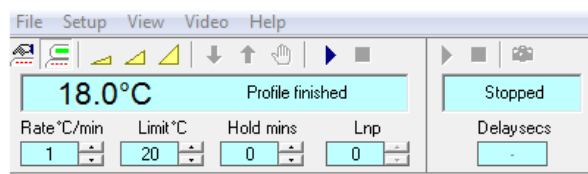



Linksys32:
Temperature and Video Capture Tool Bar

CSS450 Tool Bar

The CSS450 toolbar is made up of control buttons, sensor indicators and status window.

 When the tool bar shows this button, then the 'Jog Controls' will be active. 'Gap' setting and 'velocity' are controlled manually by typing a value. Click to toggle between 'Jog' and 'Motor Profile' controls.

 When the tool bar shows this button, then the 'Shear Motor Profile' table will be active and shearing functions will be controlled by the values in the profile table. Click to toggle between 'Jog' and 'Motor Profile'.

 This button controls the direction of steady shear (clockwise or anti clockwise) when the 'Jog Controls' are active.

 This button **Starts** the CSS450 motors according to setting in either 'Shear Motor Profile' or the 'Jog Controls'

 This button **Stops** the CSS450 motors according to setting in either 'Shear Motor Profile' or the 'Jog Controls'.

 This button moves the lid to the reference point (windows separated by 2500mm).

CSS Status Window

This shows the current status of the CSS450 e.g. the status message 'The gap motor might need to be referenced' is shown when the CSS450 is first connected.

Sensor Indicators

There are three sensors in the Lid of the CSS450, marked with the letters L, R and Z. L represents the Lid sensor, it is lit green when the Lid is in place. R represents the Reference sensor and is lit green when the Lid is at 2500mm. Z represents the Zero Sensor and is lit green when the Lid is at 0mm. T/B shows which heater is being used to display the temperature. 'Green' colour represents the Base heater and 'Red' colour represents Top heater.

Jog Controls (Manual Mode)

When the Jog control button is displayed the user can set the gap size by typing any number between 0 to 2500mm into the Gap setting box. To set rotary velocity, type a value between 1 and 10 rad/s or drag the slider using the PC mouse.

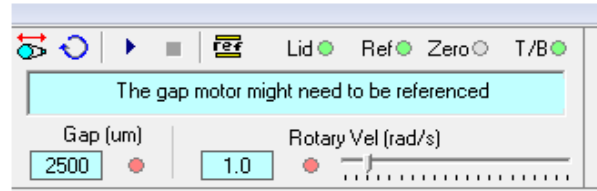

Linksys32:
CSS450 Tool Bar

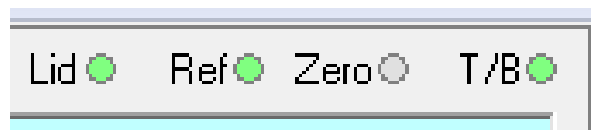

Loading the Sample

Click on the “ref” for reference button to ensure that the Lid is at the Reference Point.

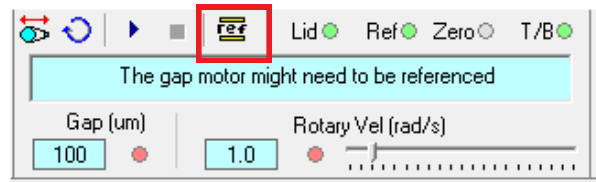

Take note of the warning popup window and move the lens clear of the lid to avoid damage.

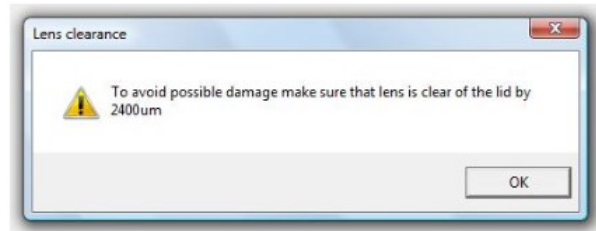

When the motor has stopped moving. Look at the ‘Gap (um)’ display and make sure it reads ‘2500’.

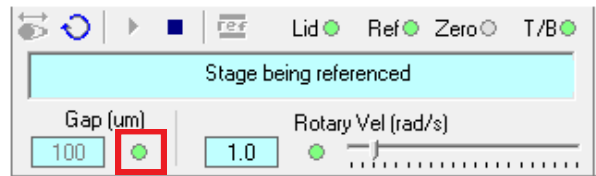

The light beside this display is red when the Gap Motor is not moving and is green when the motor is moving.

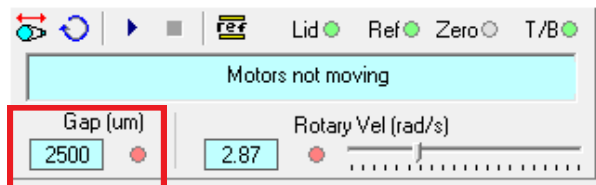

Make sure the microscope substage is in its lowest position and the lens nosepiece is rotated to a position where the Lid can be easily removed without damaging the lens or Lid.

Unscrew the Lid Nuts and remove the Lid . Place the Lid on the Stand (the picture shows the CSS450 with the Linkam Imaging Station) and place the sample in the middle of the Base window.

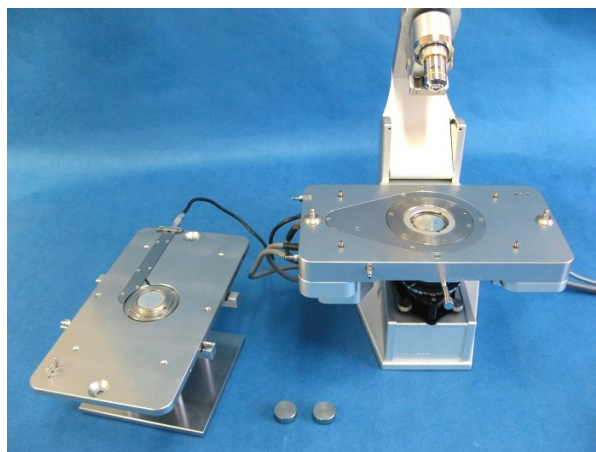

The amount of sample loaded on to the stage depends on the gap size that will be used and the transparency of the sample (if using transmitted light).

Note: If the sample is a solid it can be melted before shearing as long as the cable between Lid and Base remains connected. See the Linksys32 Manual for further information regarding temperature programming.

Replace the Lid carefully making sure the Lid Nuts are secure.

Start the Shearing Experiment

First click on the Reference button to ensure that the Lid is at the 'Reference' point of 2500mm. Take note of the warning popup window and move the lens clear of the lid.

There are two ways to control shearing in the CSS450. The Manual Jog Controls and the Shear Motor Profile table.

Using the Shear Motor Profile

To use the Shear Motor Profile table, make sure the 'Use Motor Profile' icon is visible in the tool bar.



If it is not visible, click on the 'Jog Controls' icon to switch it to the "Use Motor Profile" icon.

Click: **View > Shear Motor Profile.**

The popup window displays the table. In this table each row is made of a series of cells representing a ramp in the profile. Each column represents a setting for the ramp. e.g. Mode, Gap, Strain, Rate, Freq (frequency), Dirn (direction) and Time.

A 'Mode', 'Gap', 'Dirn' and 'Time' must always be completed to enable a successful ramp.

'Strain', 'Rate' and 'Freq' columns only need to be completed if the selected 'Mode' requires it. E.g. if a 'Steady' Shear rate 'Mode' is selected in the 'Mode' column, then the table auto completes the 'Strain' and 'Frequency' columns with 'n/a' to show that these values are not needed for this particular 'Mode'.

Right click in the 'Mode' column to show the mode drop down menu. Click on the arrows to scroll through the various possible modes.

Stdy = Steady. A continuous shear rate in the specified 'Direction' for a specific 'Time'. 0.001 to 10rads/sec.

Step = Describes a single motion at a particular shear rate and strain (angular displacement θ) in the direction set. Enter a strain value and shear rate, 0.001 to 10rads/sec.

Osc = Oscillatory. Describes a motion that follows a sine wave using the strain and frequency settings. (**Shear and Strain Explanation**, page 36).

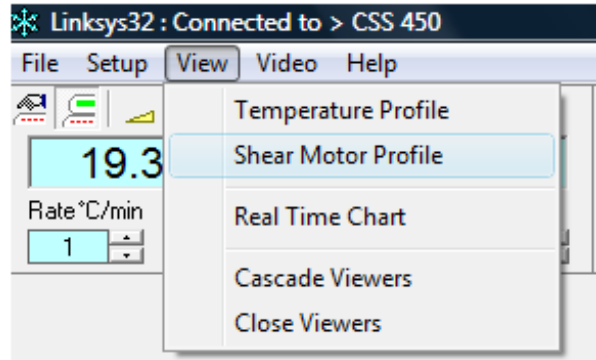
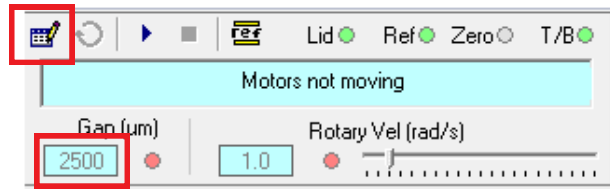

Shear Motor Profile							
Row	Mode	Gap	Strain	Rate	Freq	Dirn	Time
1							
2							
3							
4							
5							

Shear Motor Profile							
Row	Mode	Gap	Strain	Rate	Freq	Dirn	Time
1	stdy						
2							
3							
4							
5							

Shear Motor Profile							
Row	Mode	Gap	Strain	Rate	Freq	Dirn	Time
1	step				n/a		n/a
2							
3							
4							
5							

Relax = Sets the mode in which no motion takes place, only the gap and time need to be entered.

Once a 'Mode' has been set. Left Click in the 'Gap' column and enter a value between 0 and 2500mm. (Gap is the distance between shear windows).

The next column is 'Strain'. If 'Step' or 'Osc' Modes have been selected, the user will need to enter a 'Strain' value (**Shear and Strain Explanation**, page 36). Left click in the column and type the value required.

The next column is 'Rate'. If 'Steady' or 'Step' Modes have been selected, the user will need to enter a 'Rate' value.

The next column is 'Frequency'. If 'Osc' Mode has been selected the user will need to enter a Frequency of Oscillation.

The next column is 'Direction'. Click the arrows to select CW (clockwise) or ACW (anti-clockwise).

The next column is 'Time'. Enter a time (Seconds or Minutes can be selected in the CSS450 Setup menu) to set the duration of ramp until CSS450 proceeds onto next ramp in profile.

For the information entered into a cell to be registered by the controller, the user must click into another cell. The information is not stored until this has been done.

When the ramp information has been entered, the user can check that it is correct by 'Left Clicking' into the Ramp column, then Right clicking and selecting 'Check Row' from the drop down list.

If a cell contains a value that the CSS450 is not able to execute, then a warning box will appear with a message detailing the possible parameters for that particular cell.

A profile may exist of several ramps (rows). It may not always be necessary to start the profile from Ramp 1. To select the 'Start' and 'End Ramp' (row) Left click into the Ramp column, then Right Click on the particular Ramp (or Row) you want the Profile to start with and select 'Start Row' from the drop down list. Do the same for the End Row. Start Rows are green, End Rows are red.

The profile can be saved for later use.

Click: **File > Save > Shear Motor Profile**

Shear Motor Profile							
Row	Mode	Gap	Strain	Rate	Freq	Dirn	Time
1	stdy	100	n/a	0.1	n/a	acw	10
2	step	100	600.0	1.0	n/a	cw	n/a
3	osc	60	300.0	n/a	0.8	cw	3
4							
5							

Shear Motor Profile							
Row	Mode	Gap	Strain	Rate	Freq	Dirn	Time
1	stdy	100	n/a	0.1	n/a	acw	10
2				1.0	n/a	cw	n/a
3				n/a	0.8	cw	3
4							
5							

Start the Profile

Now that the 'Shear Motor Profile' table is complete the system can then be used to start shearing the sample.

For additional control of the temperature and image capture during the experiment, refer to the appropriate sections of the Linksys32 Manual.

To start shearing click on the '**Start**' button in the CSS450 Control Panel. The 'Start Ramp' turns to a light blue colour to show that it is the current active ramp. The Status window message will change to show that the motors are moving. To stop the profile, click on the '**Stop**' button at any time.

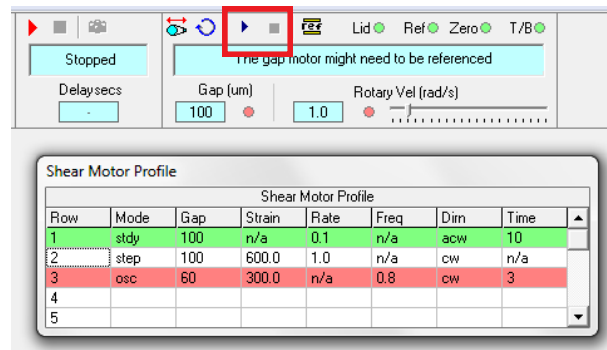

Adjusting the Shear Parameters

Accessing the Setup Menu:

To access the Setup menus for the CSS450. Right click on the Tool bar within the CSS450 control panel.

General Setup

Motor Profile Time Units - Specify units for each Ramp in the Profile by clicking either 'Seconds' or 'Minutes'.

Temperature Source - The Lid and Base have an independently controlled heating element. The user can select whether the temperature displayed in the Live Temperature Window is from the Lid or Base heater or both (mixed). If 'Bottom' is selected, the T/B indicator in CSS450 control panel will be lit Green. If 'Top' is selected the T/B indicator will be lit Red. If 'Mixed' is selected the indicator will flash alternately Red/Green.

Rotary Motor Current - The user can set how much current is supplied to motors. If the samples have high viscosity, then select 'High'. In most cases it is OK to leave this feature set to 'High'.

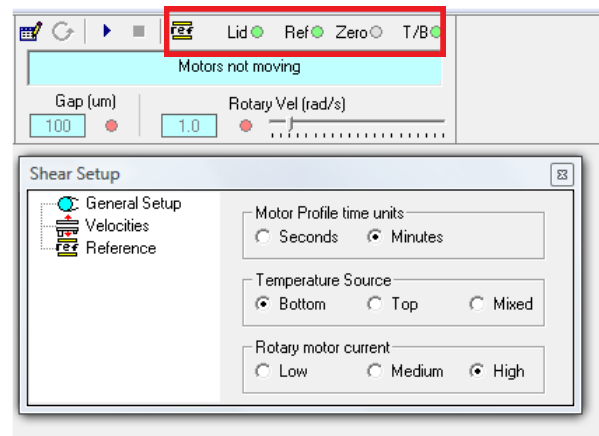

Velocities

Withdrawal Velocities - The two variables that can be changed are related to the referencing of the CSS450. The Rotary velocity is the speed at which the bottom shear window rotates as the Gap is increased. This Rotary Velocity is to help prevent the shear windows breaking when used with particularly viscous samples. The Withdrawal Velocity is the speed the Lid raises to the reference point.

Gap Velocity - This is the default speed for the lid movement (up/down) when following the Shear Motor Profile.

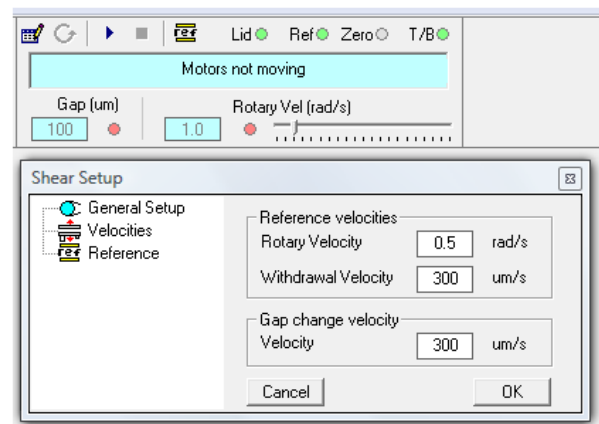

Finish a Shearing Experiment

After the experiment click the Reference to open the Lid.

Beware of the warning popup window and move the lens clear of the Lid to avoid damage.

Remove the Lid and place it on the Stand (the pictures show the CSS450 with the Linkam Imaging Station). Remove the sample and use a soft cloth with a small amount of IPA (isopropanol) to clean the quartz windows.

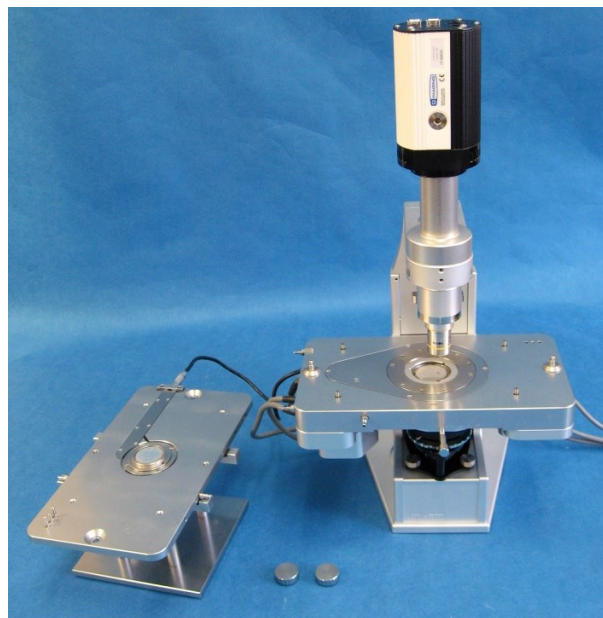
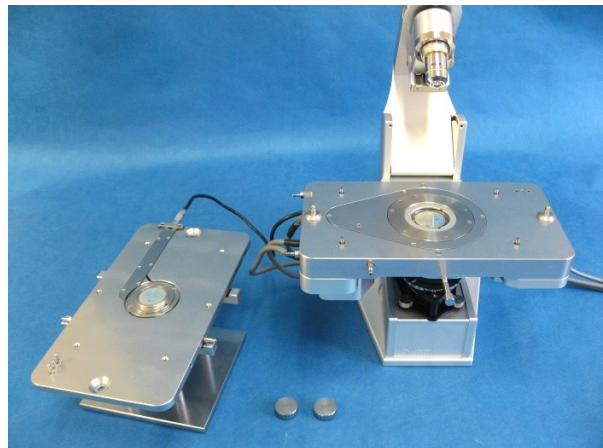
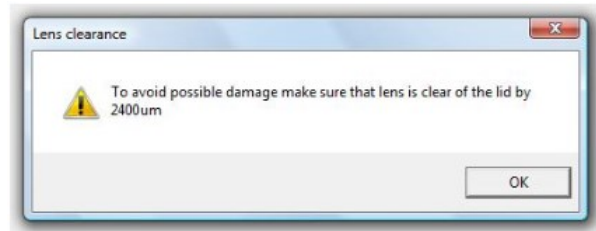
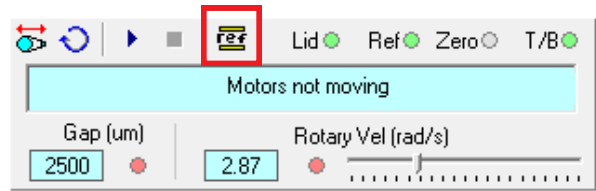

Maintenance Procedures

Changing the Windows

This section is only to be use, if any of the quartz windows are broken and need replacing.

Before leaving Linkam Scientific Instrument Ltd., each stage is calibrated and checked for parallelism of the Lid and Base windows.

When changing any windows, it is most important that the surfaces are clean. Otherwise the parallelism of the windows and the gap settings will be affected.

Refer to pages 8 and 37 of this manual for the full description and part number of the tools and accessories needed to replace the windows.

External Window Replacement

Using the External Window Clamp Tool (1), unscrew the External Window Ring (2) and remove the 18mm diameter quartz window (3). Do the reverse to replace the stage with a new quartz window. Do not over tighten as this could damage the quartz window.

Base Window Replacement

If you have the CSS-450 purge system, you will have a slightly different window clamp tool, see page 33.

When the Base window needs to be replaced, it should be reassembled as follow:

1. Using the Base Window Carrier Tool (4) to give leverage use the 55mm Window Clamp Tool (5) to unscrew the Window Clamping Ring (6) that clamps the 55mm diameter Quartz Base Window (7) in place.
2. With the help of the 55mm Window Sucker Tool (8) provided, remove the old quartz window. Then clean the recess where the window sits.
3. Place a new quartz window into position and make sure that it drops into the bottom of the recess.
4. Replace the clamping ring and screw it down until it just touches the window.
5. Tighten the ring with the tool.

Note: The window clamping ring has a rubber seal on its bottom to secure the quartz window in place and to give it good thermal contact with the heater. Do not over tighten the clamping ring, as it could brake the quartz window. Hand tight is sufficient.

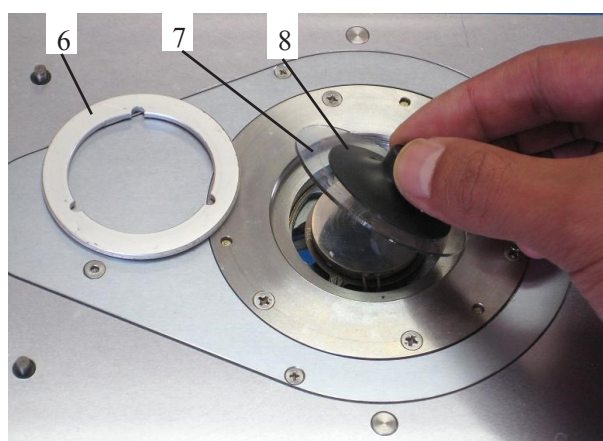
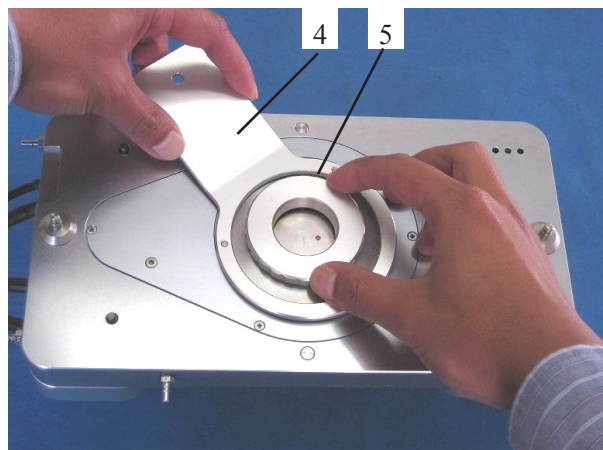
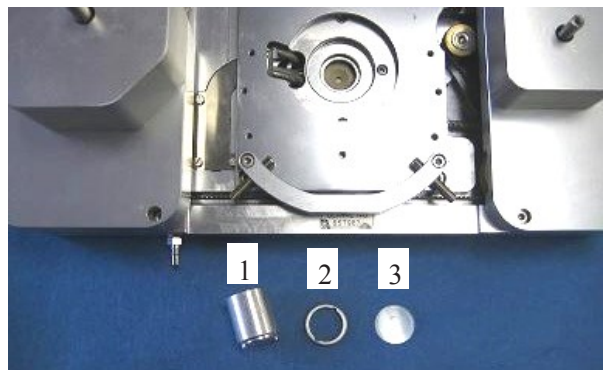
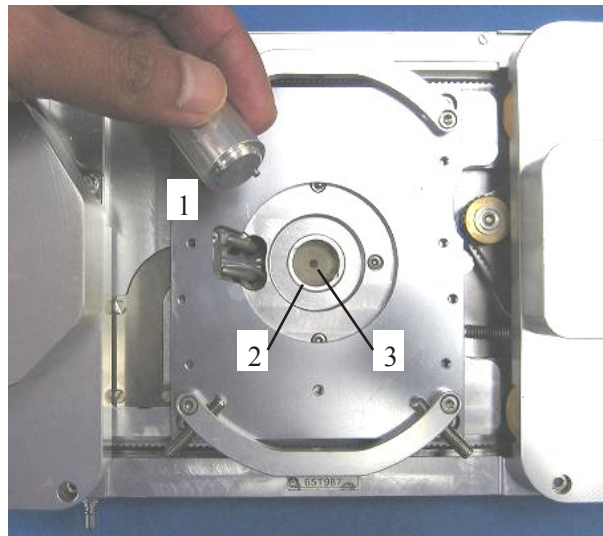

Lid Window Replacement

When the Lid window needs to be replaced, it should be reassembled as follow:

1. Using the Lid Window Carrier Tool with Tommy Bar (1). Unscrew the Window Clamping Ring (2) that clamps the 32mm Diameter Quartz Tapered Edge Lid Window (3) in place.
2. Remove the quartz window and clean the clamp thread and the surface of the heater.
3. Place a new quartz window into position, with the smaller diameter facing the clamp.
4. Screw the clamp loosely back into position. As it is being hand tightened, move the window gently from side to side to make sure that the quartz window is centralise and sit in the right position.
5. Using the tool, tighten the clamping ring. It may be necessary to use the tool's Tommy Bar, but do not use excessive force.

Note: The gap setting may need to be recalibrated when one or both of the Lid and/or Base windows have been replaced. Refer to Setting the Sensors - Zero, Lid and Reference, page 28 for more information.

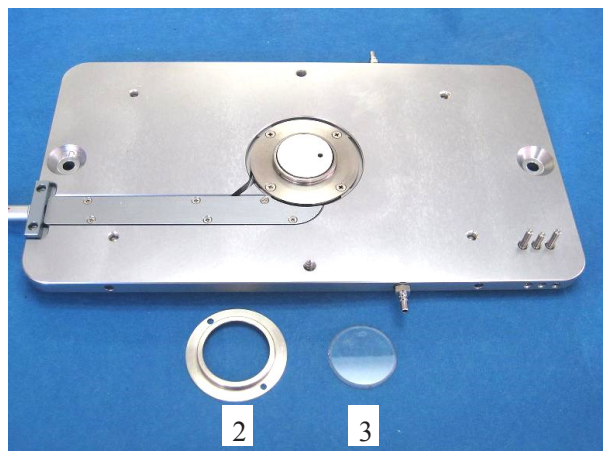
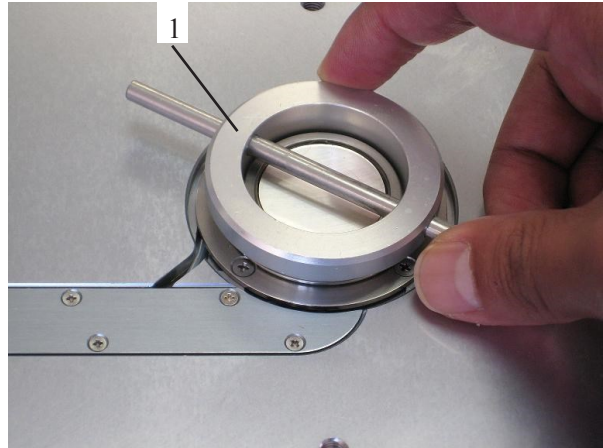

Setting the Sensors - Zero, Lid and Reference

The CSS450 shearing cell sensors are setup and calibrated at Linkam production facility, before shipment.

ONLY PERFORM THE FOLLOWING SET-UP IF YOU ARE REPLACING EITHER OR BOTH OF THE LID AND BASE SHEARING WINDOWS (page 26 and 27).

There are three sensors, R, Z and L arranged on top corner of the Lid. These three sensors determine when the Lid is at:

- R- The Reference 'Ref' point (Lid shear window is 2500mm from Base shear window).
- Z- The 'Zero' point (Lid and Base windows are separated by 0mm).
- L- The 'Lid' gap just shows the Lid is in correct range



Manually Setting the Windows to Zero Point

SWITCH OFF the CSS450 Controller and remove the CSS450 shear cell lid. Fit the Manual Gap Setting Tool to the shaft of the Gap Motor. This shaft protrudes from the smaller of the two motor covers. The tool is similar to the Lid Nuts (which secure the Lid in place) but have two extra hex grub screws (1) inserted in the side.

Slide the tool onto the shaft and tighten the grub screws with the appropriate hex key to secure the tool in place. It is now possible to easily turn the shaft when the Lid is in place.

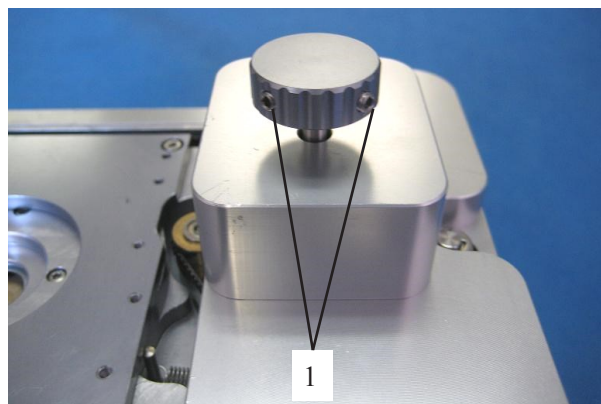

A microscope is needed to visually determine that the shear windows are at the zero point.

Use a felt tip pen to draw a line that bisects the aperture on the Base window as seen in the Picture

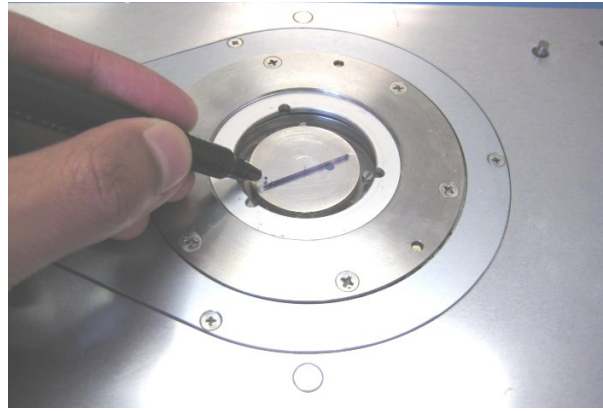

Base Window

Now draw a line that bisects the aperture in the Lid Window.

Replace the Lid on the Base (with out using the Lid Nuts) and focus with the microscope on the line drawn on the Base window.

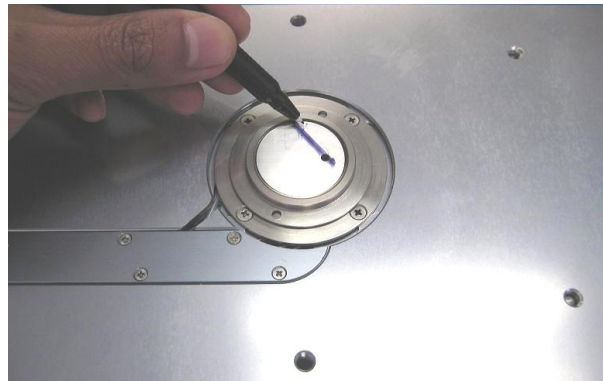

Top Window

Now turn the Manual Gap Setting Tool to lower the Lid. When both lines come into focus, i.e. when both of the shear windows surfaces are touching. This will be the manually set Zero Point. The next step is to setup up the Zero Sensors.



Switch on the controller and reconnect to Linksys32.

Click: **File > Connect**

The Status window may display the message 'The gap motor might need to be referenced' **DO NOT** click on the reference 'ref' button or the Lid will move up (2500mm) and the stage will have to be manually reset to zero point again.

Using the PC mouse, right click onto the CSS450 toolbar.

Click and select: **Reference**

Click '**OK**' to continue.

There are three sensors pins located on top of the Lid. They are labelled R (reference), Z (zero) and L (lid).

Place the Sensor Adjustment Tool on the zero sensor pin (Z).

Turn the Sensor Adjustment Tool so that the 'Zero' light in the CSS450 control panel just turns green.

One turn of the screw represents a gap of 500mm. So to get an accuracy of 1mm, it needs to be within 0.72 degrees rotation.

When Zero is set, click on the '**Zero**' button. The Lid will now move up 2500mm to the Reference point.

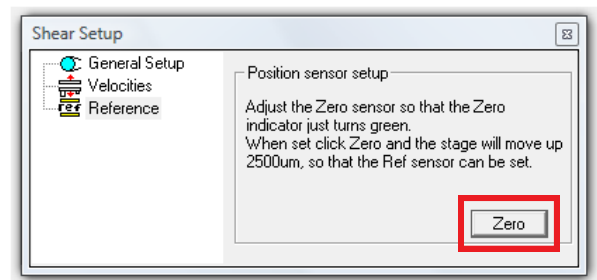
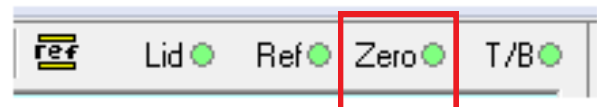
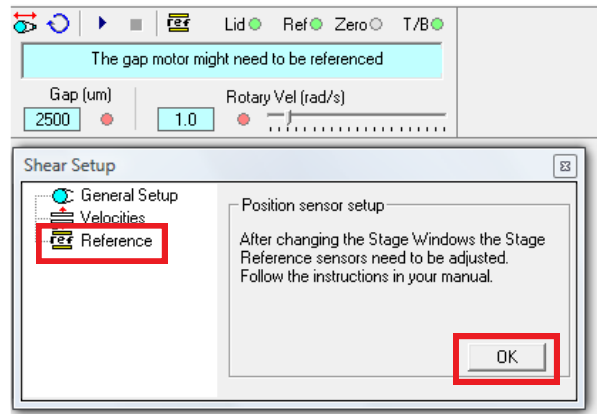

Now place the Gap Setting Tool on the Reference sensor pin (R) and turn the tool until the Reference Sensor indicator 'Ref' just turns green.

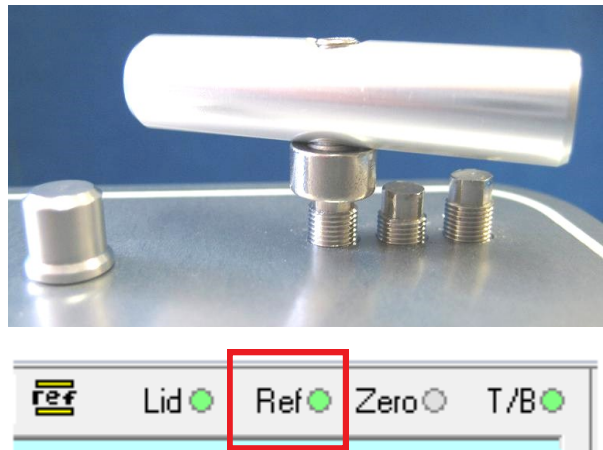

Then click 'Ref'. The Lid will now move down 500mm, so that the 'Lid' Sensor can be set.

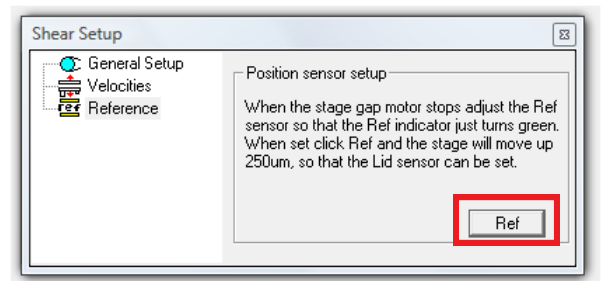

Place the Gap Setting Tool on the Lid sensor pin (L) and adjust until the Lid Indicator 'Lid' just turns green. When set, click the 'Lid' button. The motor will now move the Lid down 1000mm.

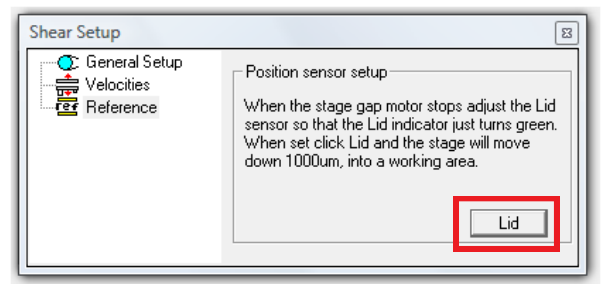
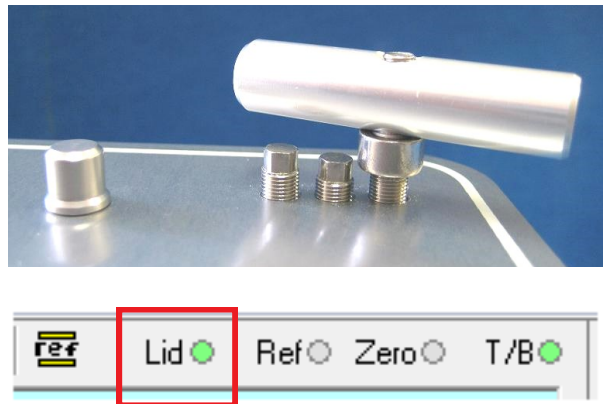

When the motor stops the there sensors will all be set up and referenced. Ready for sample loading in the next shearing run.

Click 'OK' and then click 'X' in the top corner to close the window.

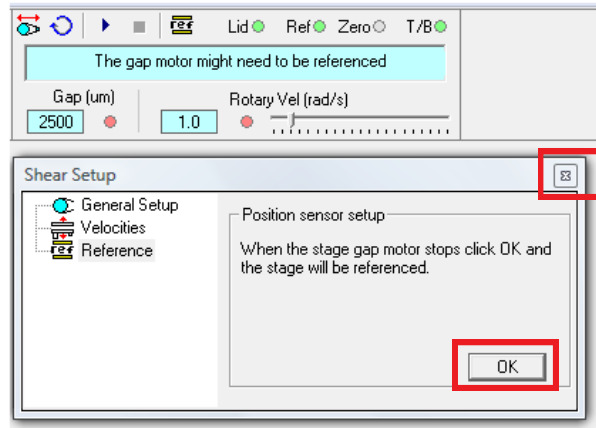

Using the CSS-450 Gas Purge and Vertical Seal stage

Only refer to this page if you have purchased the CSS-450 with additional gas purge / vertical seal option

Using the Purge ports

The vertical seal system allows the stage to be used on its side whilst preventing any leakage. To help remove or attach the lid to the stage, one of these the vertical seal plugs (1) may need to be removed to release the pressure inside the chamber.

To apply gas purging to the stage, the vertical seal plugs can be removed and replaced with the purge adaptor tubes (2).

Once the adaptor tubes are in place, an external supply can be connected to them to allow for the purging procedure to commence.

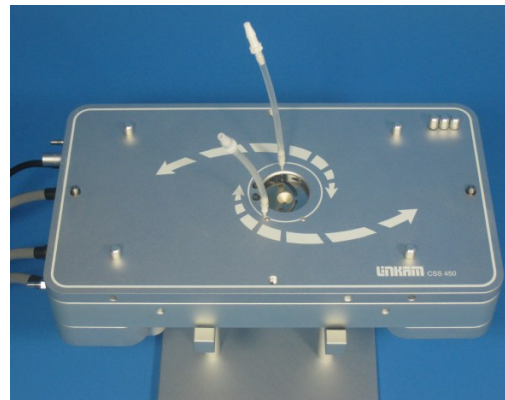
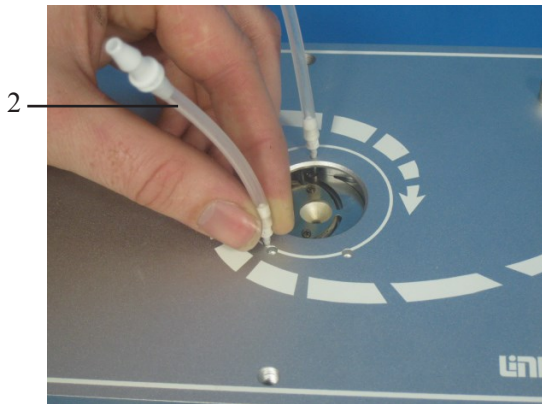
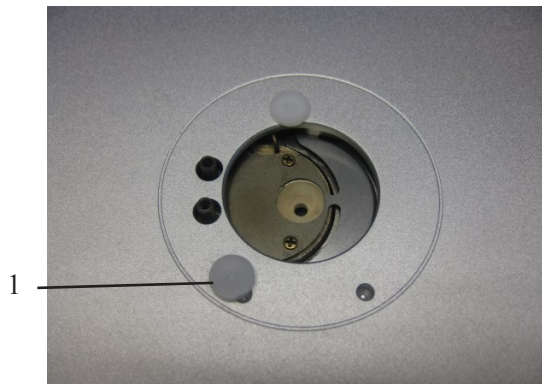

Base Window Replacement

The procedure is the same as the one shown on page 26 of this manual except that the window clamping tool is slightly different.

The clamping tool for the CSS-450 purge / vertical seal stage is shown on the right.

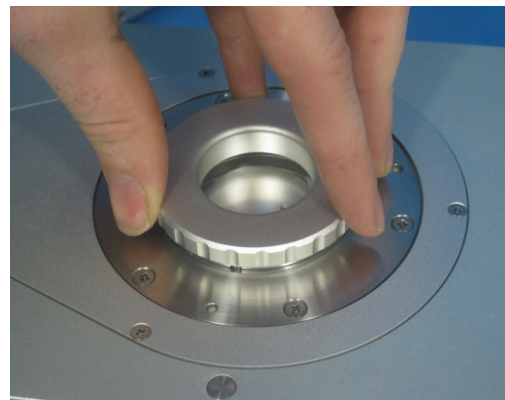

Troubleshooting

Unable to set a gap, Lid seems stuck

If the Gap Motor cannot raise/lower the Lid, it is possible that the sample may have set solid between the shear windows. By melting the sample it may be possible to part them and this should be tried first. In the event that this does not work, the following procedure should be used to force the Lid away from the Bottom. This procedure will almost certainly damage one or both of the windows. Make sure you have the appropriate spare windows in ready for the replacement.

1. Remove the instrument from the microscope and take out the external window, (see 'Changing the Windows, page 26). Place it on the Stand.
2. Using the two Jack Screws and hexagonal key provided place the Jack Screws in the holes marked Lid Jack Screws,



3. Tighten the Jack Screws by hand until they come to a stop.
4. Place the hexagonal key into one of the Jack Screw.
5. Turn the key a quarter of a turn and then do same to the other. Alternate with quarter turns so that the lid comes straight up. This will reduce the risk of any damage to the gap mechanism.
6. Clean the area around the two windows carefully before replacing them. See the section 'Changing the Windows, page 26'.

Do not use compressed air to clean the instrument as this may blow small fragments of glass into the various mechanisms.

Comm port message

The following message appears: 'Check to see if another application is using the Comm port selected or that you have the Comm port fitted to your computer?' Change the Comm port used by either moving the RS232 computer lead to another Comm port or by selecting a new Comm port using the menu.

Select and click: **Setup > Comm Port** and then select a new Comm port number (See Linksys32 Manual).

Motor doesn't start

The shear motor will not start if the Lid is off or the temperature is open circuit. It may have trouble starting if the speed selected in the Jog Window is in excess of 7.5rad/s. This can be overcome by increasing gradually from a lower velocity of say 4.0rad/s up to the desired speed, clicking the scroll bars.

It may have trouble starting if the data in the Shear Motor Profile results in a high shear rate. Decrease the value in the shear rate cell.

Lid can rock slightly when the lid nuts are off

It is quite normal for there to be a slight apparent rocking of the Lid when the gap is zero and the lid nuts are off. This is because the windows are touching and the absence of pressure from the lid nuts allows the Lid to lift a little. However, if the gap is larger than zero, there should be no rocking. In this case, contact Linkam.

Temperature appears to be several degrees below the displayed temperature

Once the heaters have reached their programmed temperature, it will normally take a minute or so for the heat to spread evenly throughout the sample. If the sample is not in a liquid state, then it may not be conducting heat as efficiently as a liquid. Should there be further cause for suspicion that the heaters are not accurate, there are procedures to verify them and check that their mountings have not been disturbed. In this case, contact Linkam.

Cooling Fault Diagnosis

Ensure that all connections to the stage and Dewar are as shown in the pictures, page 16.

The cooling rate is less than Specified

There can be several causes of this problem, the most likely being that one of the connectors has become blocked or damaged. Check that each tube is fitted tightly to the connector and that none of the tubing is twisted. This is particularly important in regard to the tubes connecting to the stage, as any constrictions of either the tubing or the connector will have a drastic effect on the cooling ability of the LNP95 pump. If the connectors and tubing are OK, check that the black capillary tubing to the Dewar flask is not bent or damaged and that the brass filter from the black capillary tubing inside the Dewar is intact and unblocked. If any damage has occurred to any of these items then it will be necessary to replace them. If no damage is found, check that the silver block is not constricted. This can be checked, simply by blowing through one of the coolant pipes. Check that there is sufficient liquid nitrogen in the Dewar so that the brass filter is beneath the surface. If the filter is lifted above the surface of the liquid nitrogen water vapour may freeze in the filter and block it. Thaw the filter to melt the ice and dry it before reinserting into the Dewar.

Appendix 1 : Shear and Strain Explanation

Shear Control

The Base window of the stage is rotated using a 1.8° stepper motor that has 200 steps per revolution ($360^\circ/1.8^\circ$). Using a technique called “micro stepping” these 200 steps may be divided up into even smaller steps for better positioning and lower resonance. Each motor step is broken up into 256 steps giving a resolution of $256 \times 200 = 51200$ micro steps per revolution

The shear motor drives the window carrier through a toothed belt to give a 4:1 velocity ratio so that for a window carrier velocity of 1 revs/sec the motor has to turn at 4revs/sec. This also means that the highest resolution in micro steps of the window carrier is $51200 \times 4 = 204800$.

The shear rates and strain values are defined below. Most Rheology systems use these.

Shear Rate

The shear rate is related to the rotary velocity at the centre of the heater aperture where the transmitted light passes. It is defined as rw/d where w is the angular velocity in rads/sec, d is the gap setting in mm and r is the observation radius (see below).

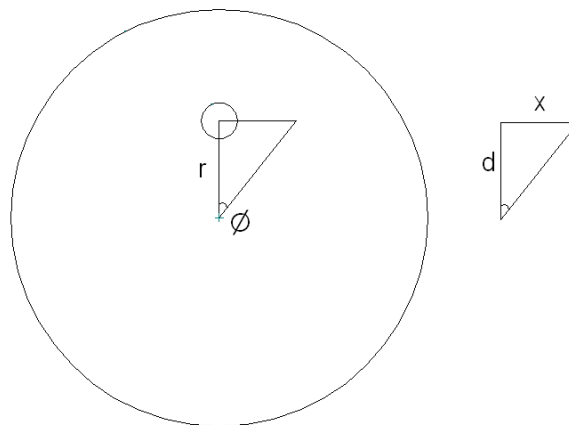

The shear rate is used to specify the velocity for the step and the steady modes and is limited to the range 0.001 to 10rads/sec. This velocity range will also affect the range of values available in the oscillatory mode, as it is the frequency and amplitude that dictate the angular velocity.

Strain (Shear) value

The strain is related to d and the observation radius r and is entered as a percentage value from 0.1 to 40000%. For a given gap setting d the angular displacement x gives the Strain or Shear $= x/d = r\Ø/d$. When entering the Strain value, d and r are known, so $\Ø$ may be calculated and converted to an angular movement in motor steps. Therefore the strain sets the angular distance in the step mode and the amplitude in the oscillatory mode.

E.g. In step mode a strain value of 1 at a gap setting of 500mm gives an angular distance of:

$$1 \times 500 / 7500 = 0.066 \text{ rads or } 3.8^\circ$$

This angular distance is then converted to a number of motor steps. In the oscillatory mode there is a limit of 2 rads for the Strain value.

Observation Radius

The radius from the centre of the bottom window to the centre of the hole in the heater block (aperture) is 7.5mm. The aperture diameter is 2.8mm.

At the observation radius r (7.5mm) the angular rotation $\Ø$ gives the displacement $x = r\Ø$. The gap setting is d and is specified in mm, $\Ø$ is in rads.

Appendix 2 : Spare Parts List

Below is a list of spares that may be require in the future. Contact Linkam or the corresponding representative for other spare parts that are not listed below.

Part No.	Part Name	Part Description
7017	PVC1	Plastic tube for stage body water cooling
2200	WGI	Water/Gas Valve Insert
2202	WVC	Water Valve Connector
9566	VS	Complete Valve Set
2053	CSS-ACC	Accessory Kit, including all Tools. (No windows)
9575	CSS-LN	Lid Securing Nuts (x2)
2007	CSS-SB	Shear Belt
3066	CSS-SR	Stainless Steel Sensor Rods (x3)
3008	CSS-AS	Alignment Screws for CSS450 Lid (x4)
9560	NUG450	Alignment Kit for CSS450
3437	W32TQ	32mm diameter Quartz Tapered Edge Lid Window (1.5mm thick)
3438	W55QC	55mm diameter Quartz Base Window (1mm thick, 5um tolerance)
9581	W32-55SS	Set of Stainless Steel Disc (Replaces Standard Windows for x-ray)
3081	CSS-CRT	32mm Window Clamping Ring - top
3071	CSS-CRB	55mm Window Clamping Ring - bottom
3012	CSS-LR	External Window Ring
2695	W18Q0.5	18mm Diameter Quartz Window (0.5mm thick)
0997	ECP	Water Circulator Pump (110V)
0998	ECP	Water Circulator Pump (240V)
3033	N/A	Manual Gap Setting Tool

Appendix 3 : Declaration of Conformity



Declaration of Conformity

Manufacturers Name: Linkam Scientific Instruments Ltd

Manufacturers Address:
8 Epsom Downs Metro Centre
Waterfield
Tadworth
Surrey
KT20 5LR
UK

Declares that the products as originally delivered:

Product Name: Temperature Programmer
Product Number: CSS450

has been independently tested and found to comply with the following applicable European Directives, and carries the CE marking accordingly:

EMC Directive 2004/108/EC using product standard EN 61326-1:2006
Low Voltage Directive 2006/95/EC using product standard EN 61010-1:2010

and also carries the additional certification:

EMC: FCC CFR47 Part 15B

Safety: CB IEC 61010-1/ EN 61010-1
MET UL 61010-1/ CSA C22.2 No.61010-1 under listing E112928

Date: 12th July 2011

A handwritten signature in black ink, appearing to read "Peter Grocutt". The signature is written in a cursive, slightly slanted style.

R&D Manager: Peter Grocutt

Appendix 4 : Technical Specification

CSS450 Stage Technical Specification

Temperature Range: Ambient to 450°C (-50°C to 450°C for Cryo-CSS450)
 Temperature Sensor: Platinum Resistor
 Gap Motor: Precision 200 step. 256 micro step drive.
 Main Motor: Precision 200 step. 256 micro step drive.

CSS450 Controller Technical Specification

Dimensions: 376L x 243W x 87H (mm)
 Weight: 2.6Kg (excluding cables)
 Operating Environment: 5~40°C, 80% relative humidity at 31°C decreasing linearly to 50% at 40°C (without condensation)

Temperature Range: -196°C to 450°C (dependent on Stage)
 Temperature Resolution: 0.01°C resolution (dependent on Stage)
 Temperature Accuracy: 0.05°C
 Temperature Stability: 0.05°C
 Set Point Resolution: 0.1°C

CSS450 Controller Equipment Ratings

A.C. Mains Supply: 100-240V at 47-63Hz
 Max current: 3.4A
 Fuse:
 Current rating 4A
 Characteristic T
 Voltage rating 250V~
 Breaking capacity H

The Anti-Surge or Time Lag (T) Fuse must be replaced by one of the same type and rating.

RS232 Computer Interface

Standard RS232 levels supplied with a cross over RS232 cable. Uses 19200 baud, 1 stop bit and no parity.

USB Interface

USB Type B connector: Currently only used for firmware updates.

External input and output sockets

Green 2.5mm stereo jack socket. Open drain output. Will sink up to 50mA at 12V.
 Pink 2.5mm stereo jack socket. Open drain output. Will sink up to 50mA at 12V.
 Blue 2.5mm stereo jack socket. Logic level input from 3.3V to 5V.

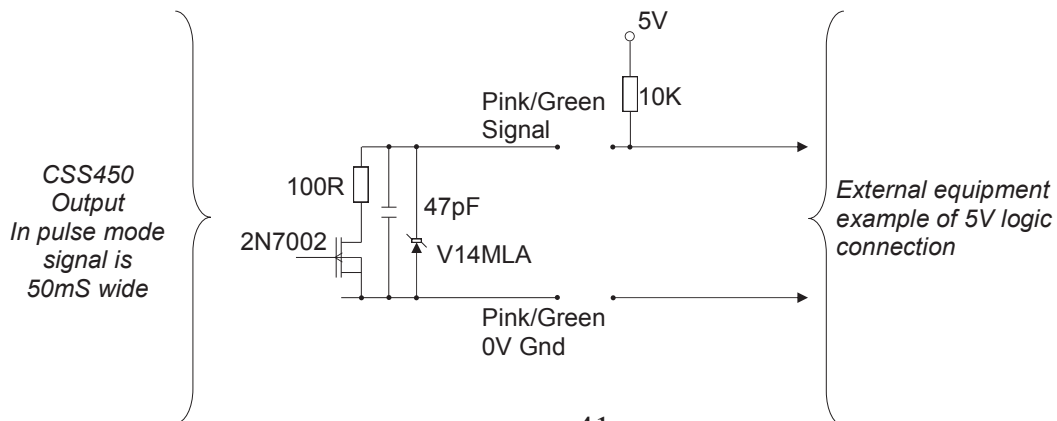

CSS450 Motor Board

Rotary Motor

Motor Type: Bipolar Stepper Motor
Motor Current: Programmable up to 2.0A
Motor Resolution: 256 Micro Steps

Gap Motor

Motor Type: Bipolar Stepper Motor
Motor Current: Programmable up to 1.0A
Motor Resolution: 256 Micro Steps

Digital Encoder: 24 bit
End Stops: 2

Optional LinkPad

Dimensions: 125L x 172W x 80H (mm)
Weight: 0.75Kg (excluding cables)
Operating environment: 5~40°C, 80% relative humidity at 31°C decreasing linearly to 50% at 40°C (without condensation)
Display Resolution: 320 X 240 pixels
Display Size: 5.7 inch
User Interface: Touch screen

LinkPad Equipment Ratings

D.C Voltage: 12V
Max Current: 550mA

LNP95 Liquid Nitrogen Pump

Dimensions: 376L x 243W x 87H (mm)
Weight: 3.6Kg (excluding cables)
Operating Environment: 5~40°C, 80% relative humidity at 31°C decreasing linearly to 50% at 40°C (without condensation)
Tubing: Silicon Rubber

LNP95 Equipment Ratings

A.C. Mains Supply: 100-240V at 47-63Hz
Max current: 1.7A
Fuse: Current rating 2A
Characteristic T
Voltage rating 250V~
Breaking capacity H

This page is intentionally blank

This page is intentionally blank

Linkam Scientific Instruments Ltd.

Tel: +44(0)1737 363 476

Fax: +44(0)1737 363 480

Email: support@linkam.co.uk

Unit 8 Epsom Downs Metro Centre

Waterfield, Tadworth, Surrey, KT20 5LR, UK

www.linkam.co.uk

Version: 1.0 Date: 17-07-2012

Version: 1.1 Date: 05-11-2013

Version: 1.2 Date: 16-12-2013

Added a French version of the safety section

Modified safety cord set information