

IOT operation in the SPS Long term experience

TWC 800 MHz

CONTENTS

- SYSTEM PRESENTATION
- OPERATION STATISTICS
- 800 MHZ OPERATION SCENARIO
- IOTs LIFE TIME DATA
- TRANSMITTER FAULTS
- IOT STARTUP MANAGEMENT
- PREVENTIVE MAINTENANCE
- EFFICIENCY
- OTHER IOT INSTALLATIONS AT CERN
- CONCLUSION



SYSTEM PRESENTATION

CERN Accelerator complex

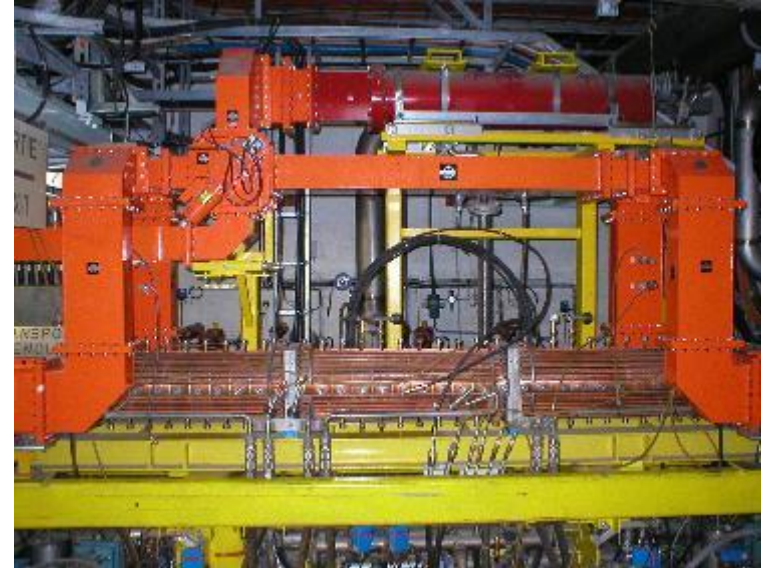
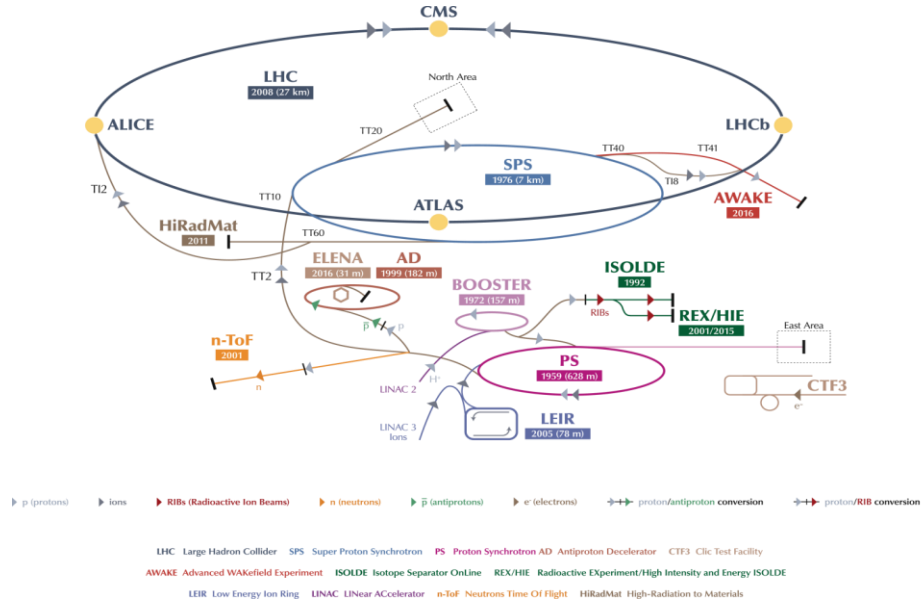

2 x 800 MHz
TW Cavity

TH795



160 KW CW per
Cavity



OPERATION STATISTICS

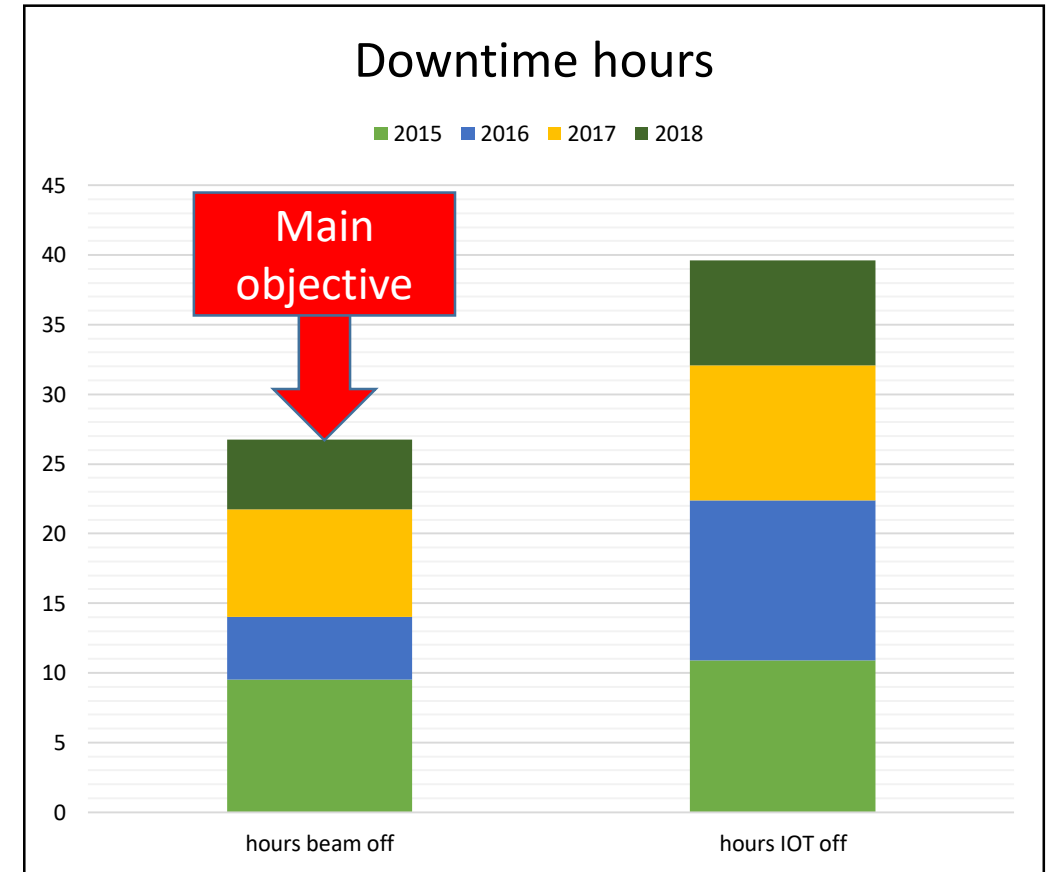
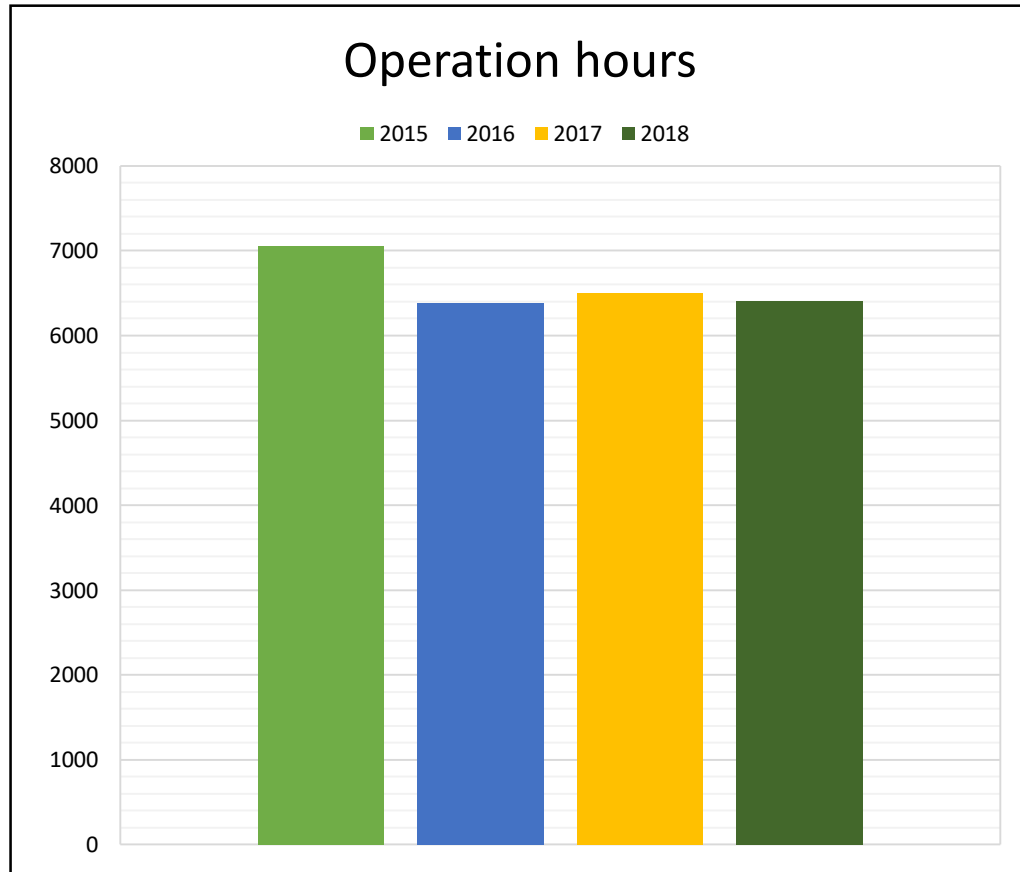

On average there was around 7000 hours off operation per year.
The availability for beam in SPS was more than 99.9 %



800 MHZ OPERATION SCENARIO

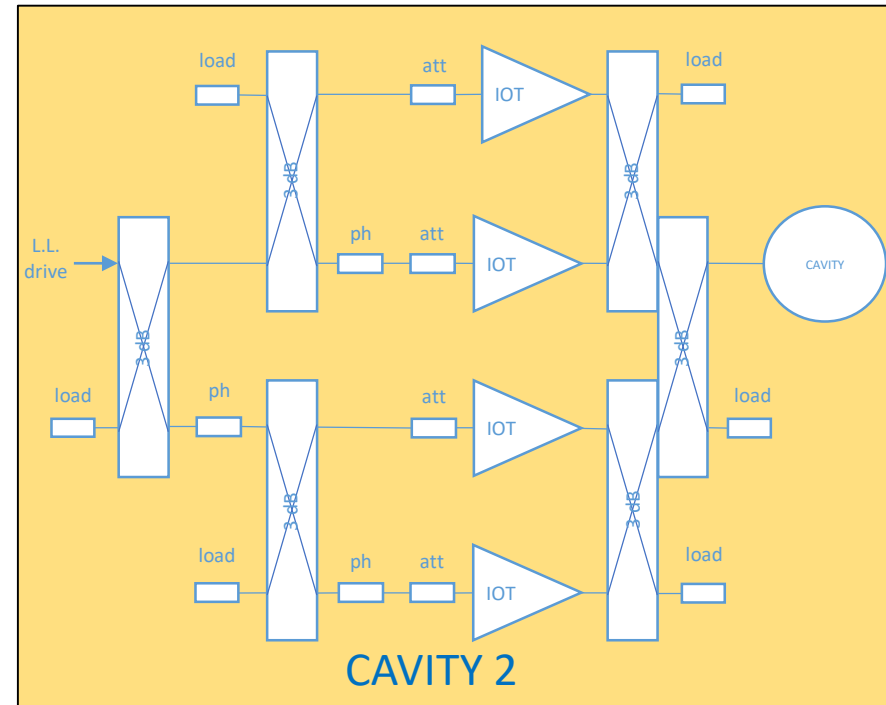
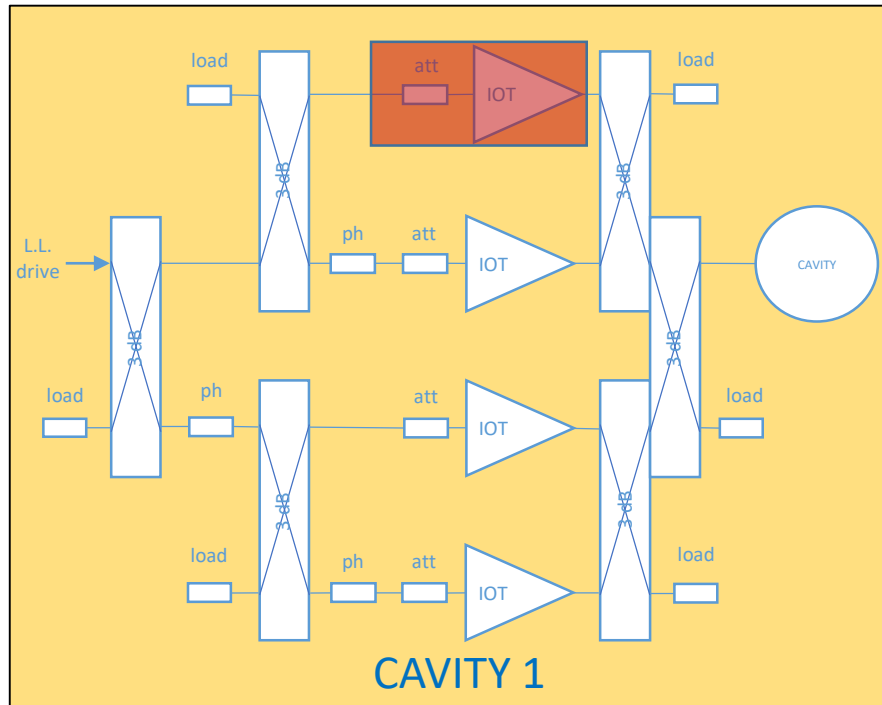

- 4 IOTs combined for 1 cavity
- The beam operation allows for 1 IOT offline per cavity
- And also, depending the users, the system allows us to have 1 cavity off !

800 MHZ OPERATION SCENARIO

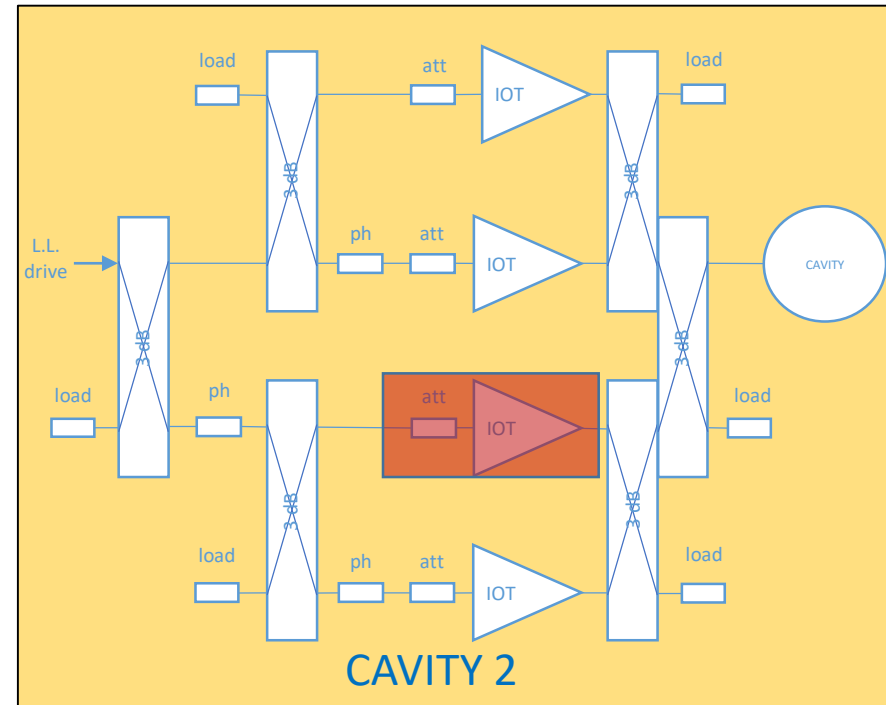
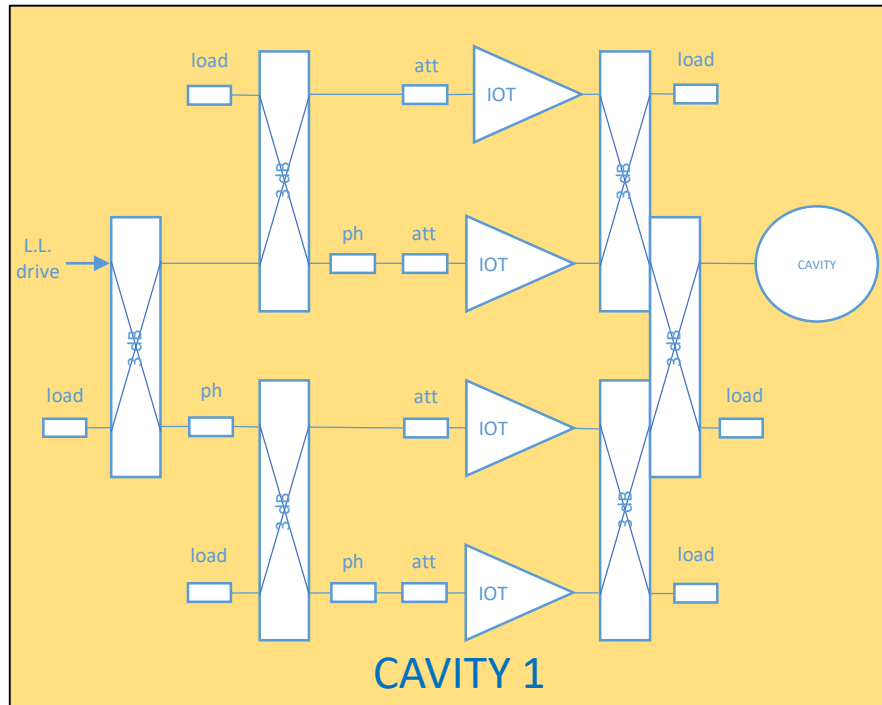

- 4 IOT combined for 1 cavity
- The beam operation allows for 1 IOT offline per cavity
- And also, depending the users, the system allows us to have 1 cavity off !

800 MHZ OPERATION SCENARIO

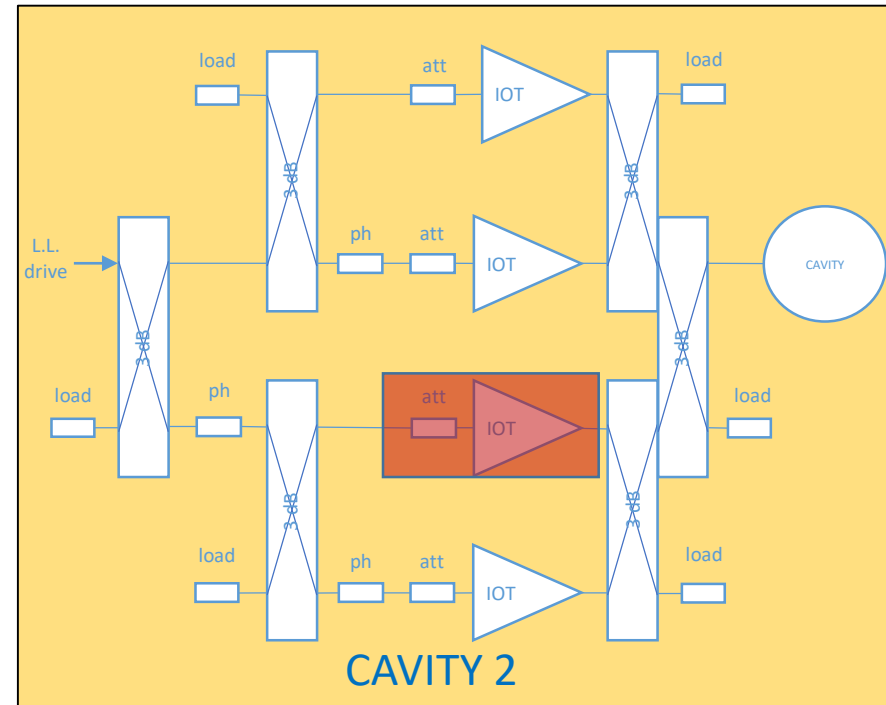
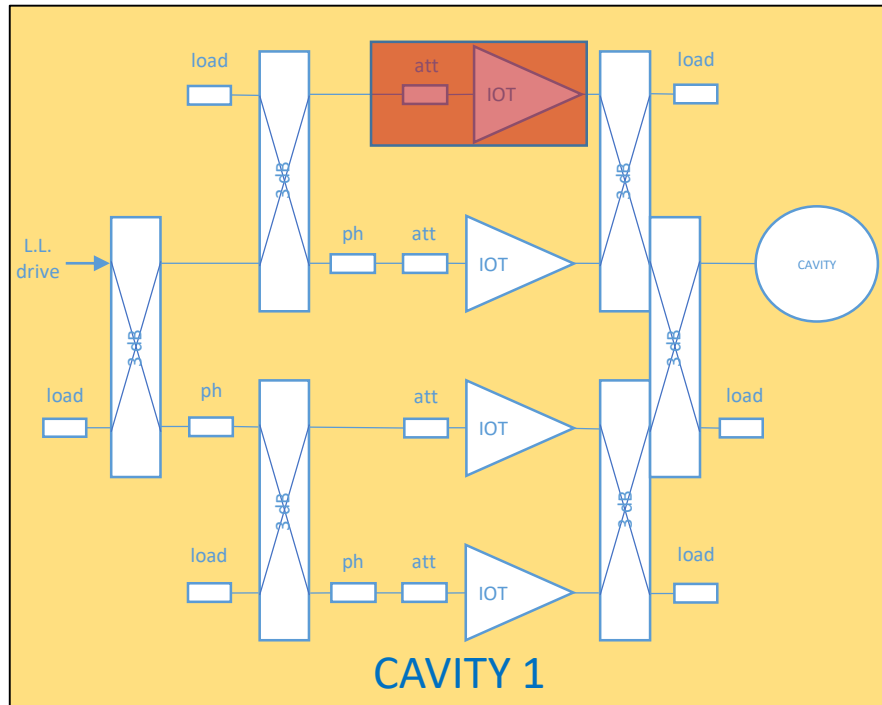

- 4 IOT combined for 1 cavity
- The beam operation allows for 1 IOT offline per cavity
- And also, depending the users, the system allows us to have 1 cavity off !

800 MHZ OPERATION SCENARIO

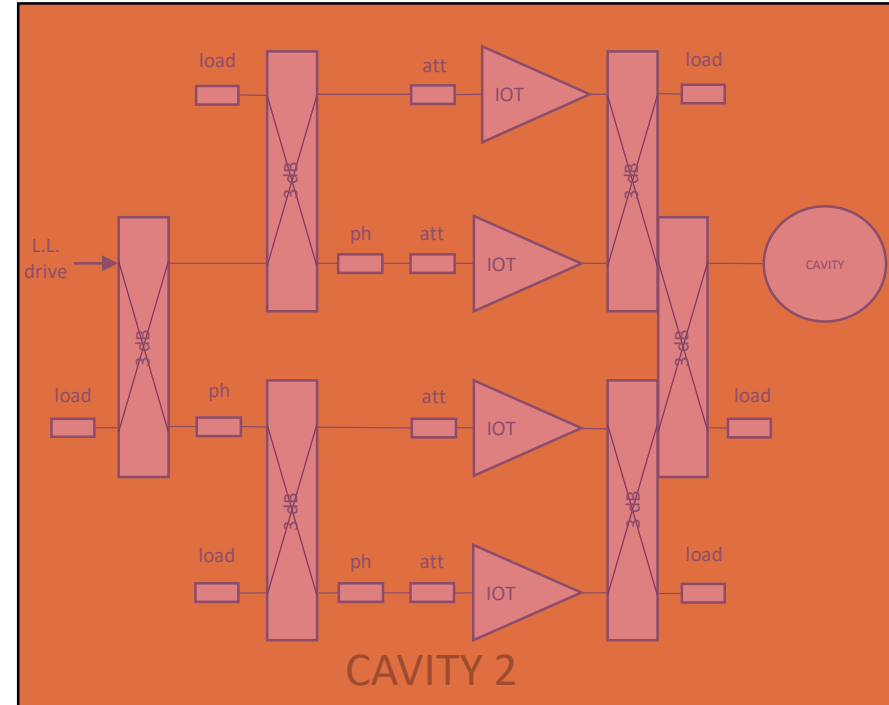
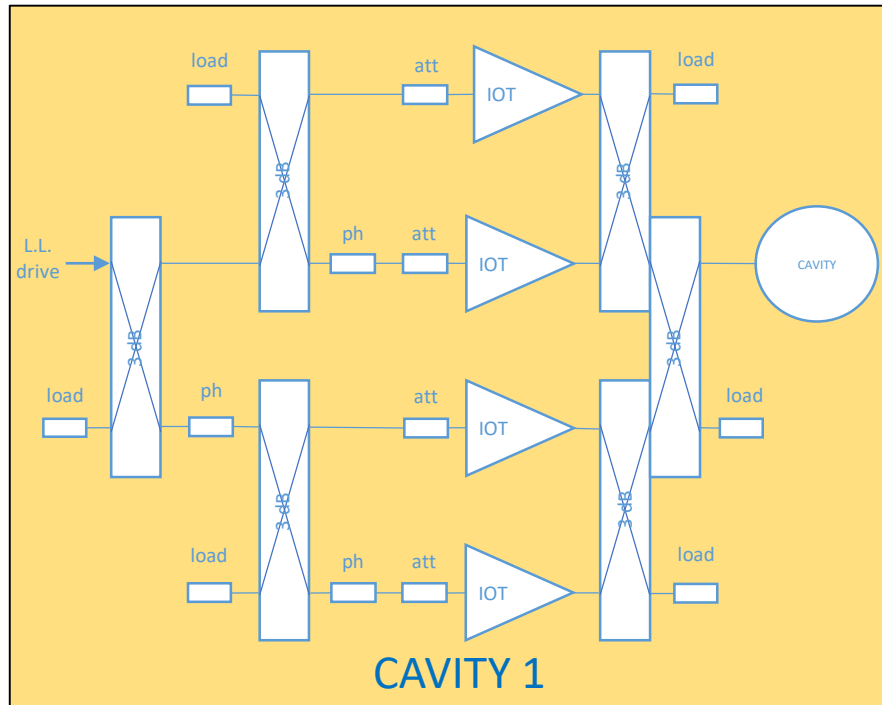

- 4 IOT combined for 1 cavity
- The beam operation allows for 1 IOT offline per cavity
- And also, depending the users, the system allows us to have 1 cavity off !

LIFE TIME DATA

- 4 years of operation
- 6 tubes now have more than 30'000 filament hours
- Only one had to be replaced current of 2018 with a 'possible' arc failure (still to be confirmed, the tube could be ok)

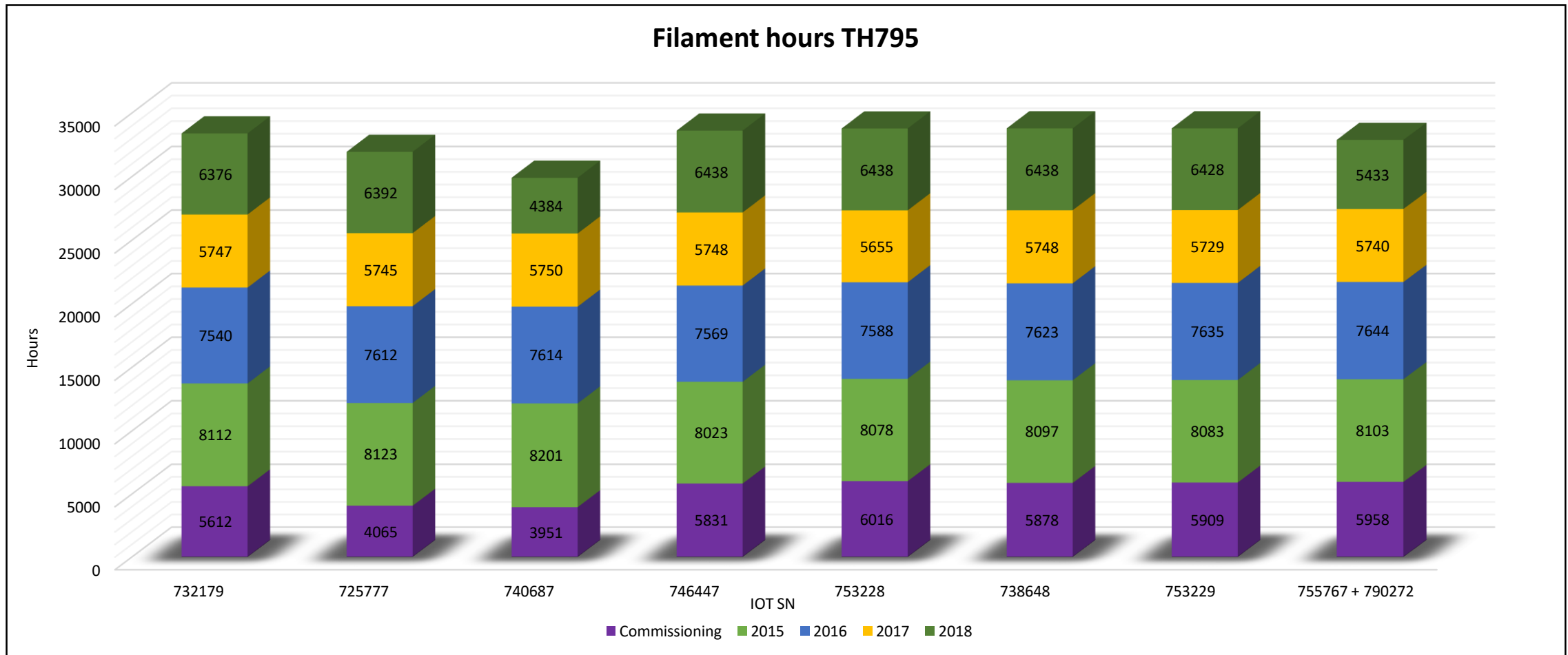

FAULTS

Intervention time (hours)

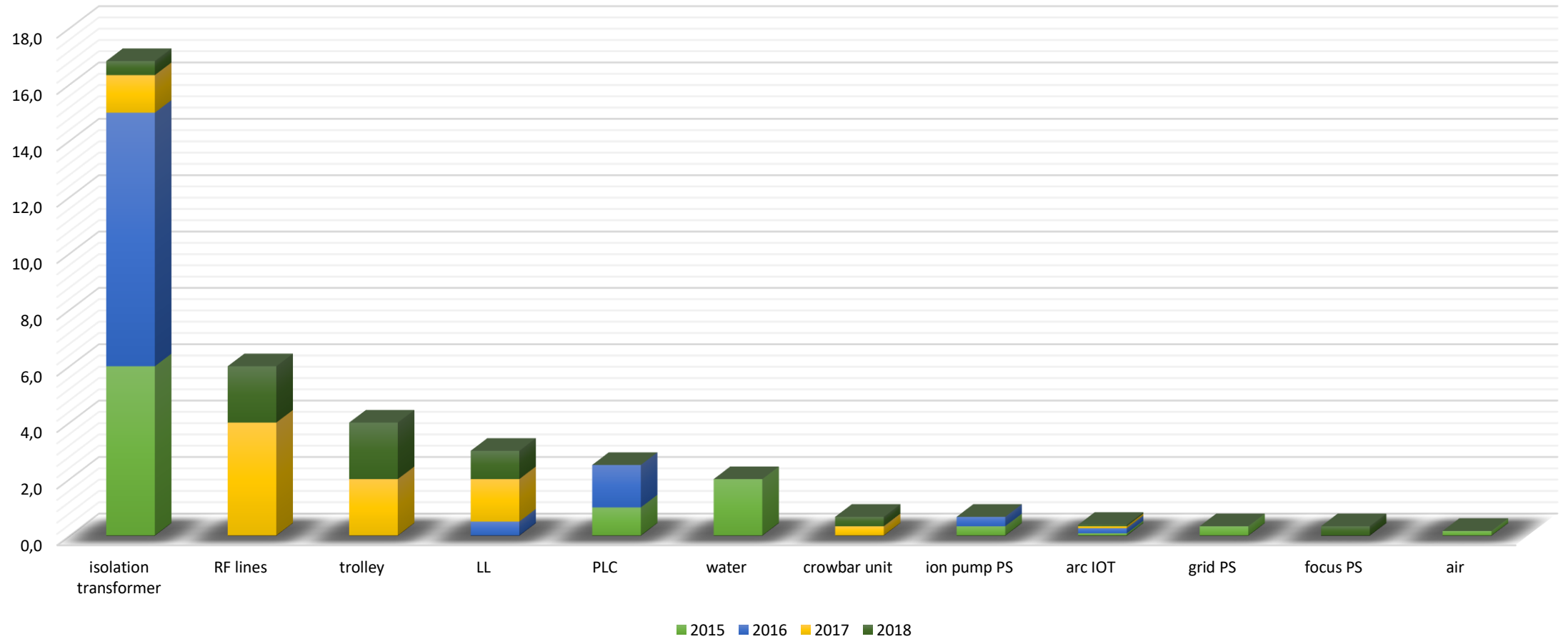

FAULTS

- Isolation Transformer :
 - Resin transformer isolated up to 60 kV DC
 - All first transformers installed came from a bad series
 - During the first two years of operation, it was difficult to identify that the problem was the transformer
 - New transformers were bought with an improved isolation
 - Interventions were always necessary to fix the trouble, main circuit breaker tripped

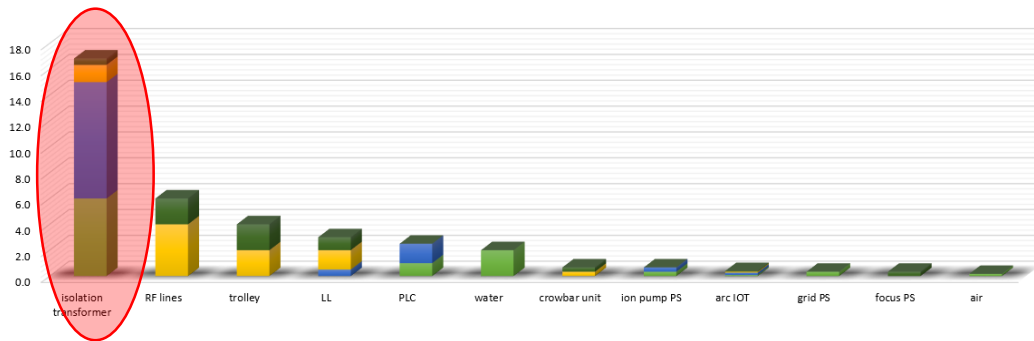

Not a thermal cause !

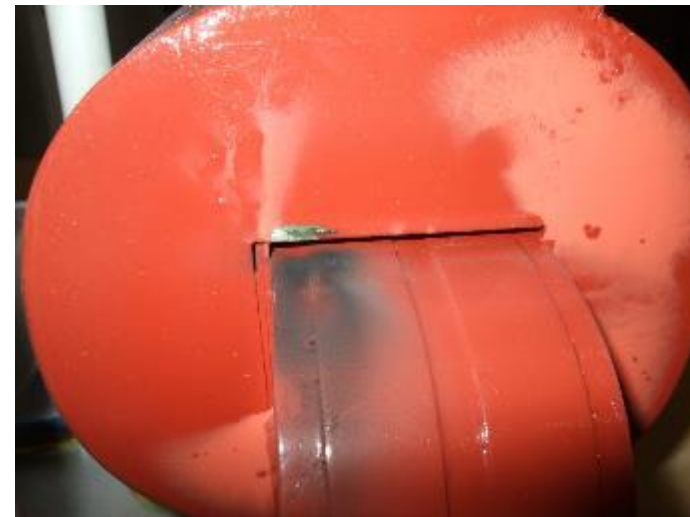

But a HV arc!



FAULTS

- Coaxial lines :
 - Some difficulties with the coaxial line assemblies were experienced
 - This was human error
 - Can appear several days after the bad contact was made.
 - The time of intervention for repair is several hours



4-1/2''
coaxial line

Inner elbow
burned

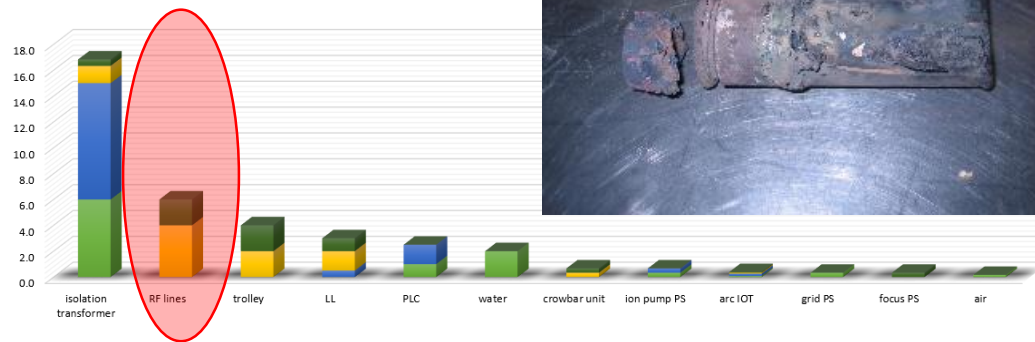

Bad contact
from the
inner clamp

FAULTS

- Trolleys :
 - The pieces between Ion pump and cathode melted due to bad soldering.
 - A second default found was a water leak on the anode contact also due to a bad brazing
 - The time to replace a trolley from the transmitter is as well several hours

Ion pump
isolation
piece



Anode cooling
pipes

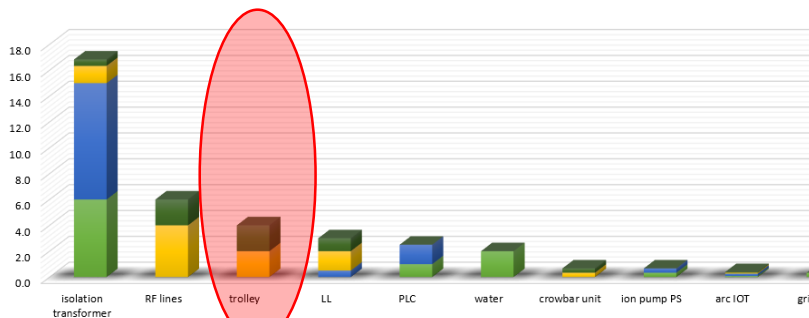

FAULTS

- Low Level RF and PLC :
 - Following the LLRF upgrade two years ago, the new 'Switch & Limit' system generated strange injections to the power system.
 - Concerning the PLC and controls, we fixed some initial problems linked with the start-up, and later troubles linked with the 'S&L' system.

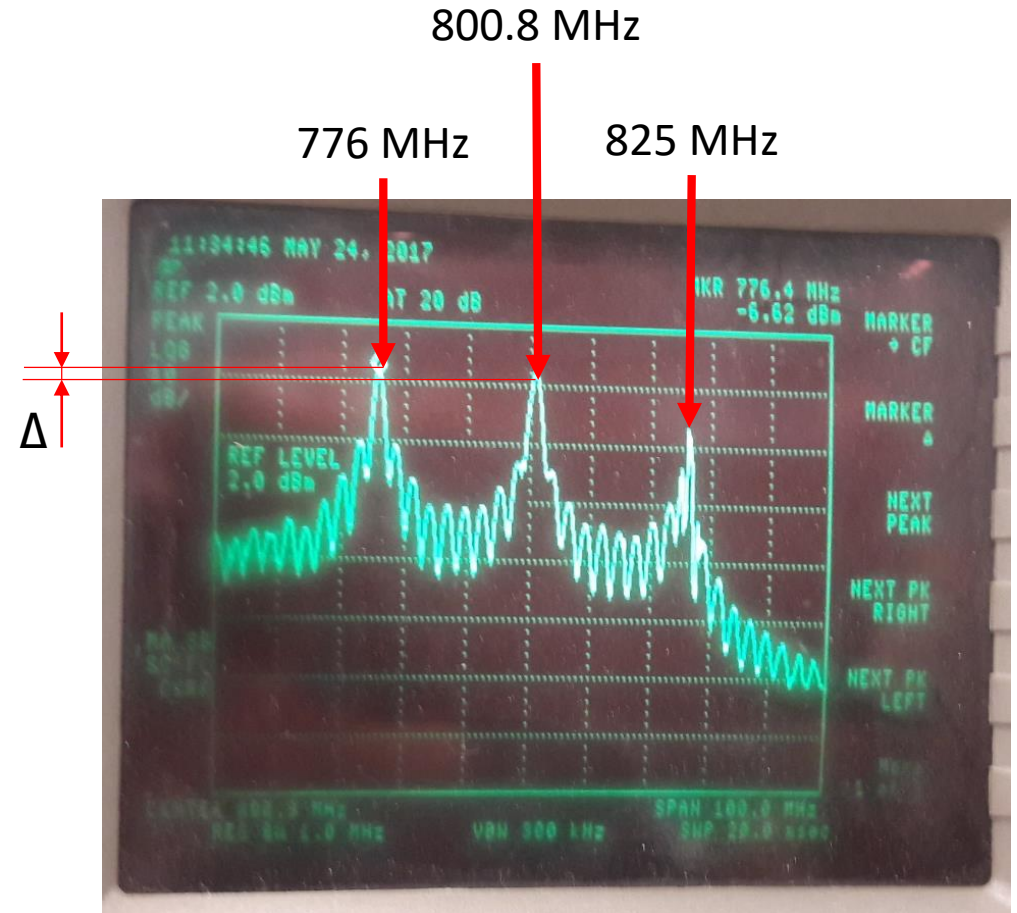
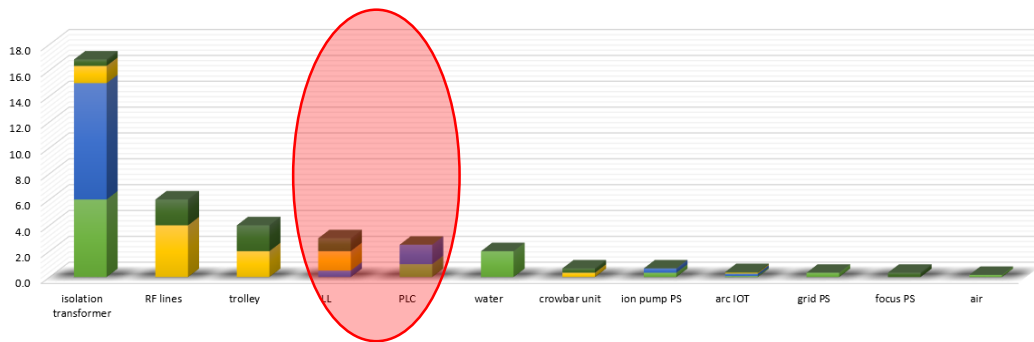

'Switch & Limit' system generated harmonics (- 25 MHz / + 25 MHz) even higher than the fundamental !



IOT STARTING UP MANAGEMENT

First start (at reception of the tube before storage or after a long (years) storage)

IonPump & Filament : 24 hours
HV (20 kV / 0.2 A) : 1 hour
HV (30 kV / 0.2 A) : 1 hour
HV (35 kV / 0.6 A) : 1 hour
HV (35 kV / 0.15 A) : 1 hour
RF (CW half power) : 30 min
RF (CW full power) : 30 min

Second start (after storage, less than a year)

IonPump & Filament : 2 hours
HV (20 kV / 0.2 A) : 30 min
HV (30 kV / 0.2 A) : 30 min
HV (35 kV / 0.6 A) : 30 min
HV (35 kV / 0.15 A) : 30 min
RF (CW half power) : 30 min
RF (CW full power) : 30 min

Long stop (hours or days)

IonPump & Filament : 2 hours
HV (20 kV / 0.2 A) : 30 min
HV (30 kV / 0.2 A) : 30 min
HV (35 kV / 0.6 A) : 30 min
HV (35 kV / 0.15 A) : 30 min
RF (CW half power) : 30 min

Short stop (minutes)

IonPump & Filament : 10 min
HV (35 kV / 0.15 A) : 0 min
RF (CW full power) : 0 min

In case of more difficulties for the start up of an IOT, we do a conditioning on table up to 45 kV (35 kV in operation). In addition we also reduce the filament current with respect to ageing given Thales indications.



• PREVENTIVE MAINTENANCE •

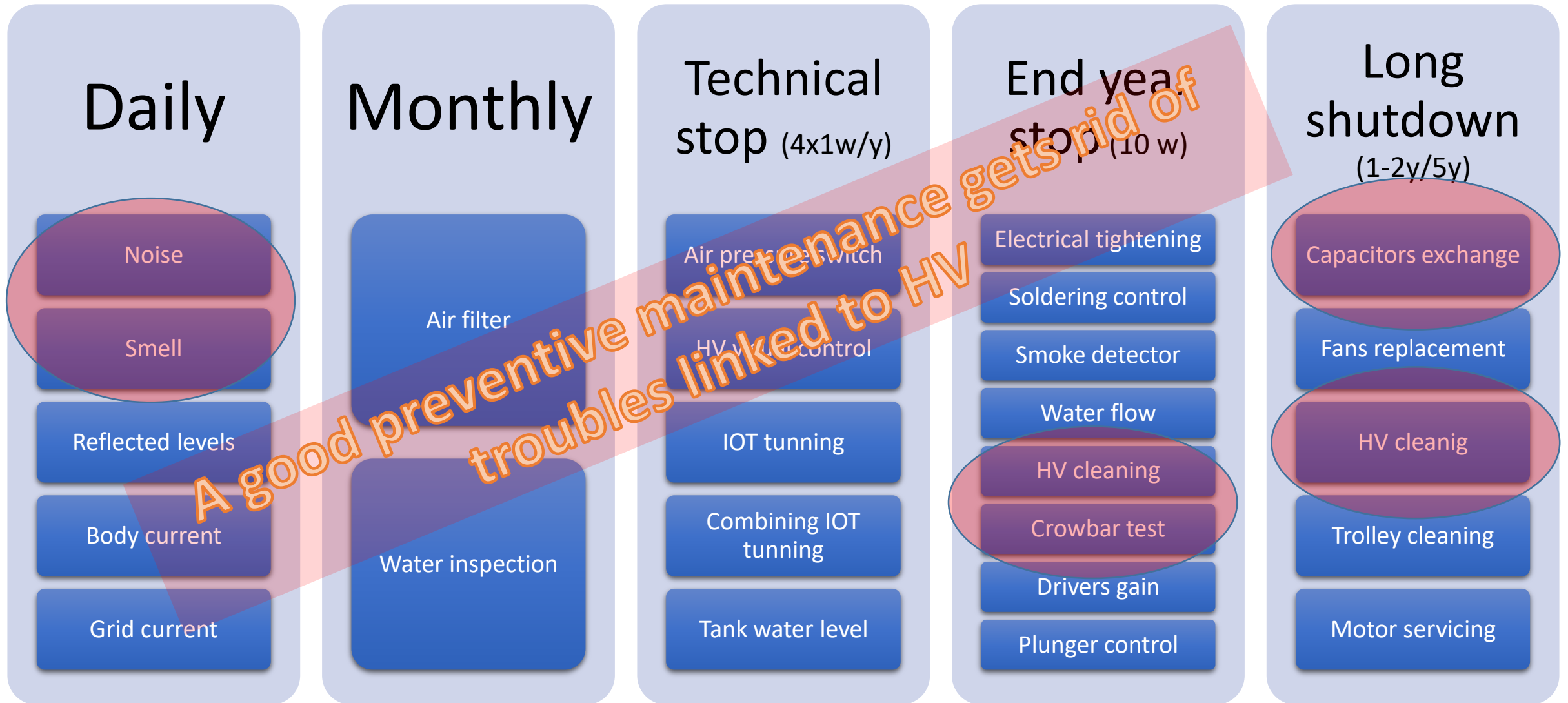

• PREVENTIVE MAINTENANCE •

- Smoothing capacitors :
 - The Low Voltage capacitors (400 VAC) for the HV smoothing in Electrosys cubicle is an important point for the maintenance and operation
 - The lifetime in operation is rated 20'000 hours
 - The shelf life is variable depending on temperature

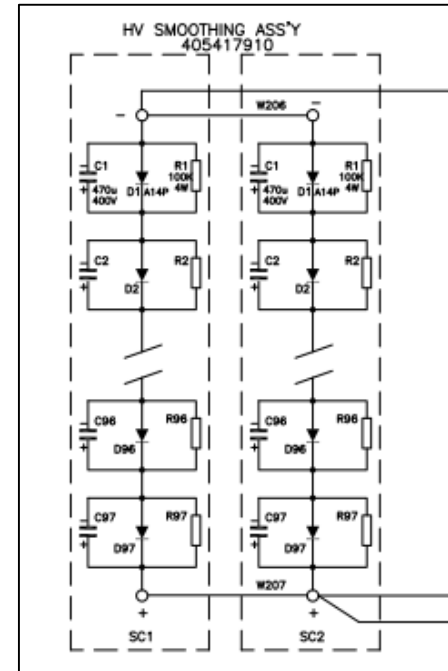
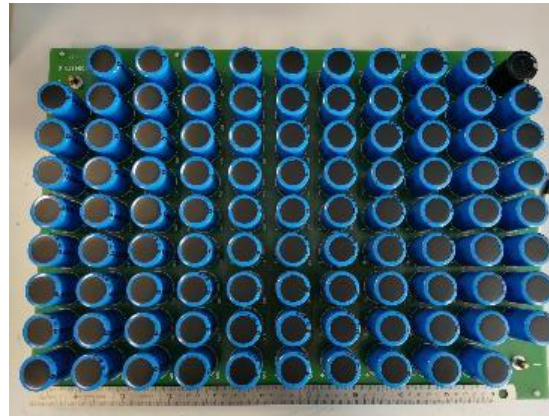
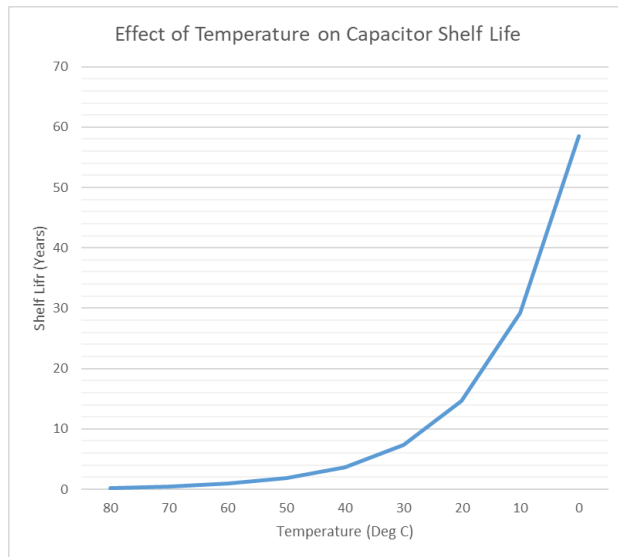

• PREVENTIVE MAINTENANCE •

- Grid cleaning process :
 - Following the recommendation from Thales, we do a grid cleaning
 - The initial excess of barium from the cathode moves to the grid, and after around 5'000 hours this starts to induce thermal grid current
 - We implemented our own system, and after our process the complete thermal grid current disappears by removing this excess of barium from the grid
 - The cleaning was for the moment necessary only one time for each IOT



EFFICIENCY

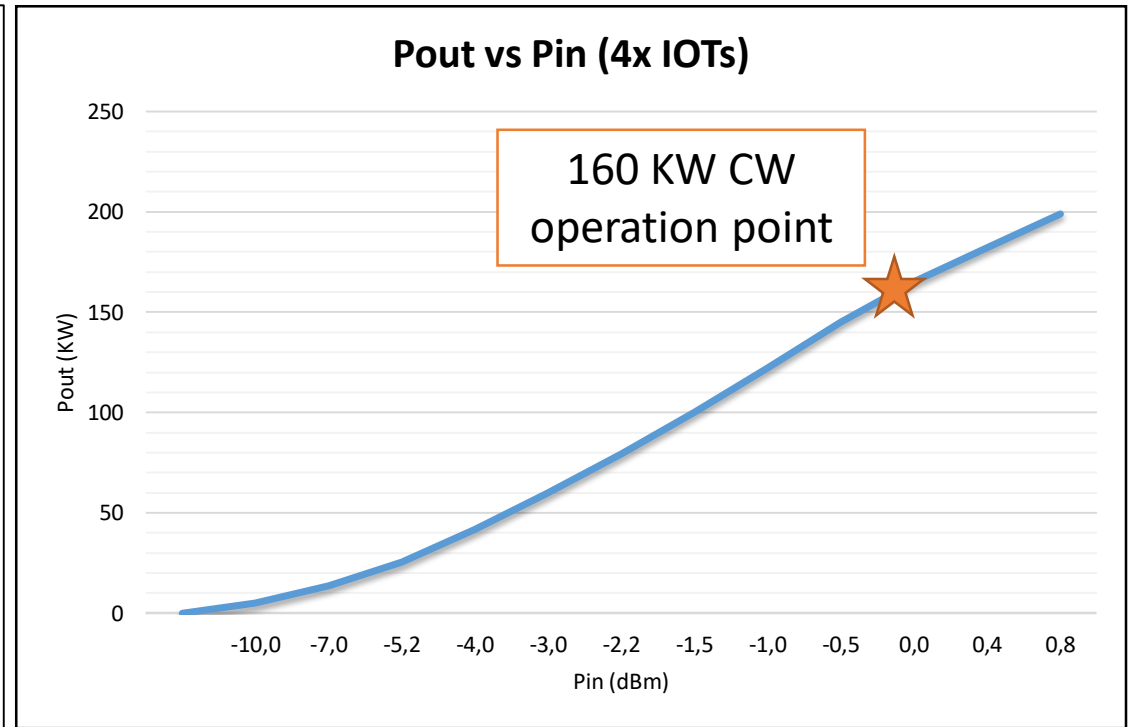
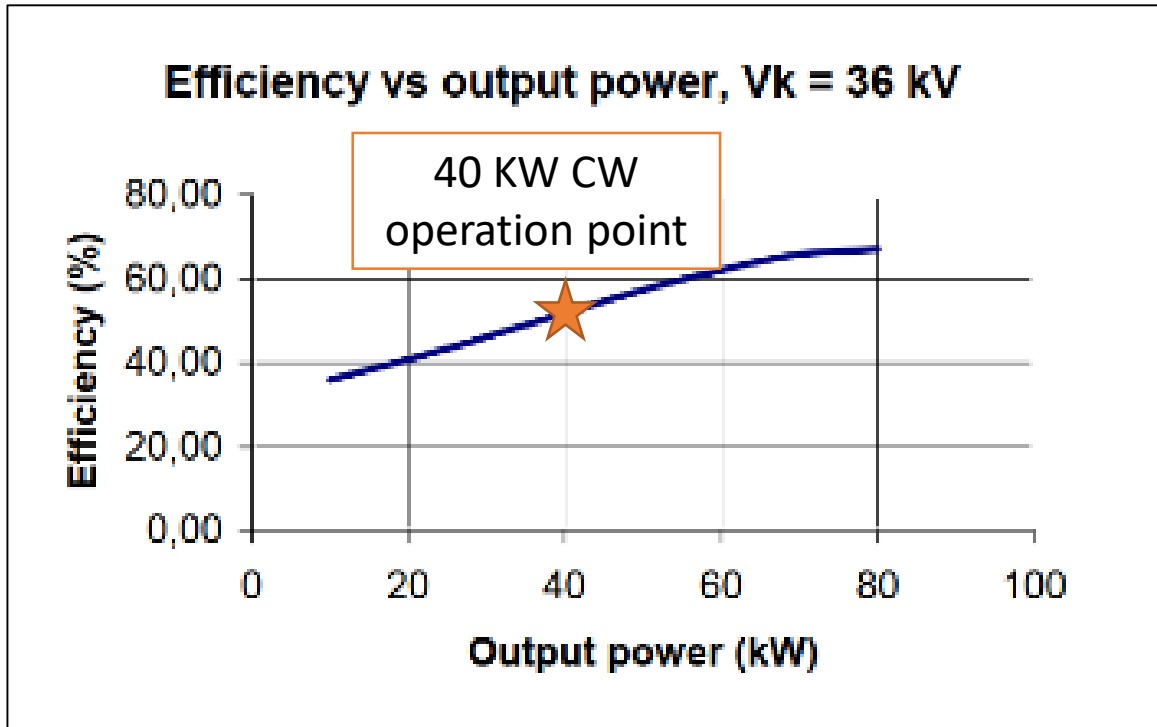

In order to guarantee availability for the beams, and include margin requested by the LLRF, we decided to operate the tubes at a lower point of operation than the maximum available.

Lower point of operation also increases lifetime of tube.

We demonstrated that this is very efficient for the availability of the system.



• OTHER IOT INSTALLATIONS •
@CERN



SPS Crab cavity

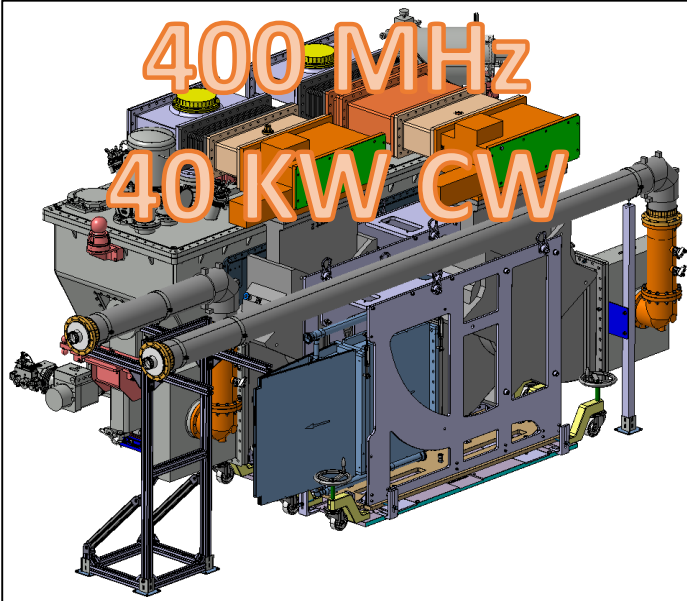

400 MHz
40 KW CW



Medical RFQ

750 MHz
100 KW Pulsed

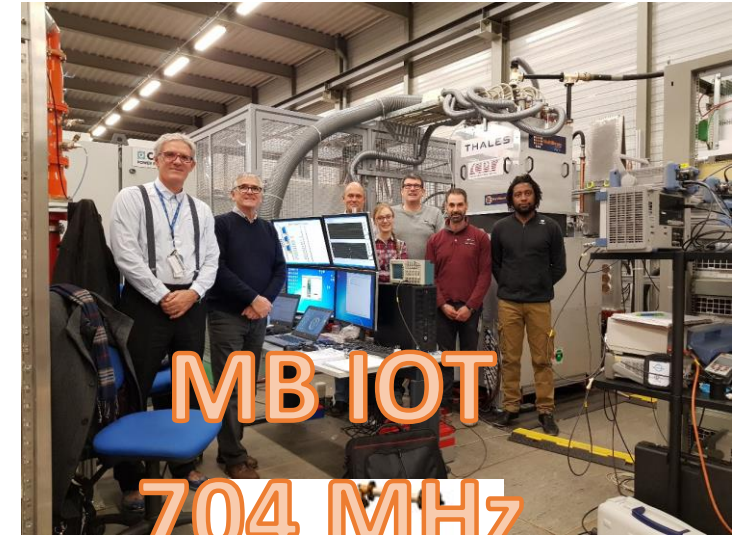

MB IOT
704 MHz

1.2 MW Pulsed

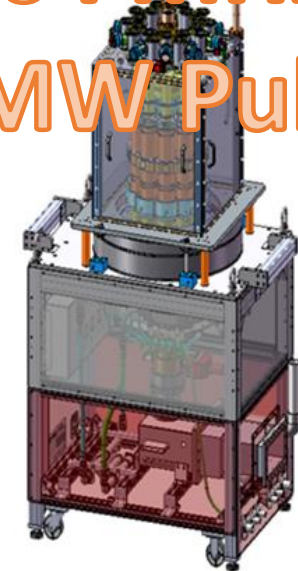

CONCLUSION

- Our IOT system is now mature and has proven to be very reliable, ensuring a high availability for the beams
- IOT itself demonstrated to be very robust and easy to operate
- IOT has the advantage of a high gain, needing only a few hundreds of Watt driver
- IOT offers a high power density (HVPS can be aside and quite far away)
- Given the LLRF requirements of margin, IOT offers a very good DC to RF efficiency
- IOTs are absolutely fantastic !
- IOTs should always be considered for RF systems for accelerators !
- Thank you for your attention

